



Installation and Maintenance Manual

CTC EcoZenith i360

Indoor model with heat pump control

3x400V / 1x230V / 3x230V



Important!

- Read carefully before use, keep for future reference.
- Translation of the original instructions.

Table of contents

1. Important! Information on air bleeding	3	9.11 Wiring diagram CTC EcoZenith i360 3x230V Flow heater E15.....	39
2. Safety instructions	4	9.12 Wiring diagram CTC EcoZenith i360 3x230V Terminal Block X2.....	40
3. Important to remember!	5	9.13 Connection table for electrical components.....	41
3.1 Transportation.....	5	9.14 Wiring diagram for Expansion card.....	44
3.2 Positioning.....	5	9.15 Connection table for Expansion Card A3.....	45
3.3 Recycling.....	5	9.16 Sensor connection.....	46
3.4 After commissioning.....	5	9.17 Current sensor connection.....	48
4. Your home's heating installation	6	9.18 Setting electrical output in backup power supply.....	48
5. Technical data	10	9.19 Resistance table for sensor.....	49
6. Measurements	11	10. Installation Communication	50
7. Overview CTC EcoZenith i360	12	10.1 Install ethernet cable.....	51
7.1 Options with CTC EcoZenith i360.....	13	10.2 Remote - Screen Mirroring.....	52
7.2 Basic installation, CTC EcoZenith i360.....	13	10.3 myUplink - App.....	52
7.4 Delivery includes:.....	14	11. First start	53
7.3 Compatible heat pumps.....	14	11.1 Installation wizard.....	54
8. Pipe installation	15	12. Operation and Maintenance	55
8.1 Schematic diagram for air-to-water heat pump.....	16	13. System adjustments	56
8.2 Schematic diagram for brine-to-water heat pump.....	17	13.1 Adjust circulation pump.....	56
8.3 Full schematic diagram.....	18	13.2 Pump curve for heating medium system circulation pump.....	59
8.4 Interactive schematic diagram.....	19	13.3 Flow check.....	59
8.5 Install hot water pipe.....	20	13.4 Pressure differential for heating medium side.....	60
8.6 Install pipe for radiator system.....	21	13.5 Extra functions.....	61
8.7 Install pipes to and from the heat pump.....	23	14. Control system	71
8.8 Install waste water piping.....	24	14.1 Navigate on the touchscreen.....	71
8.9 Fill the heating circuit.....	25	14.2 Start menu.....	71
8.10 Bleed the entire system.....	26	14.3 Alarm management.....	71
9. Electrical installation	27	14.4 Heating/Cooling.....	72
9.1 Overview of basic electrical installation.....	28	14.5 DHW.....	76
9.2 List of functions.....	29	14.6 Ventilation.....	76
9.3 Electrical parts list.....	30	14.7 Schedule.....	77
9.4 Wiring diagram CTC EcoZenith i360 3x400V Relay card A2.....	32	14.8 Operation data.....	79
9.5 Wiring diagram CTC EcoZenith i360 3x400V Flow heater E15.....	33	14.9 Display.....	89
9.6 Wiring diagram CTC EcoZenith i360 3x400V Terminal Block X2.....	34	14.10 Settings.....	91
9.7 Wiring diagram CTC EcoZenith i360 1x230V Relay card A2.....	35	14.11 Define.....	113
9.8 Wiring diagram CTC EcoZenith i360 1x230V Flow heater E15.....	36	14.12 Service.....	127
9.9 Wiring diagram CTC EcoZenith i360 1x230V Terminal Block X2.....	37	15. Factory settings EcoZenith i360	132
9.10 Wiring diagram CTC EcoZenith i360 3x230V Relay card A2.....	38	16. Troubleshooting	135
		16.1 Troubleshooting, heat.....	135
		16.2 Troubleshooting, hot water.....	136
		16.3 Information messages.....	137
		16.4 Alarm messages.....	138
		16.5 Critical alarms - Risk of freezing.....	140

Software update



software.ctc.se

EN

For more information on updated functions and downloading the latest software, see the website "software.ctc.se".

1. Important! Information on air bleeding

For the product to work as intended, the system must be fully bled.

It is extremely important that a basic bleeding of the product is carried out systematically and carefully.

Bleeding devices must be fitted to the system's natural high points. A basic bleeding of the hot water tank can be carried out upon installation by releasing the safety valve, which must be fitted to the top of the product.

The water must be circulated during bleeding of the various subsystems: the radiator systems, heat pump system and hot water charging system (to run the pumps, 3-way valve etc. manually, go into the menu Installer/Service/Function test). Also move the 3-way valve during the bleeding process. A careful basic bleeding must be carried out before the system is put into operation and the heat pump is started.

Tip:

Once basic bleeding is complete: increase the water pressure in the system temporarily to approx. 2 bar.

- Automatic bleeding valves are included in the package and supplied as standard for this product. They must be fitted to the top of the product as shown in the picture.
- Important! Bleed any air remaining in the radiators (elements) and other parts of the system after it has been in operation for a short time.

Small microbubbles gradually collect in the system's 'pockets', and it can take quite a long time before all the air is removed from the system. When the pressure is temporarily increased, any remaining air pockets are compressed and carried along more easily with the flow of water and can be released into the ventilation devices.

Tip:

After the air is bled, there may be a drop in system pressure. Having the system pressure too low increases the risk of noise in the system and of air being 'sucked' in on the suction side of the pump. Keep an eye on the system pressure. Bear in mind that the system pressure will vary during the year due to changes in temperature in the heating circuit, which is completely normal.

If 'gushing' sounds can be heard from the product, this is a sign of remaining air.

A loss of heating functionality can also be a sign of remaining air.

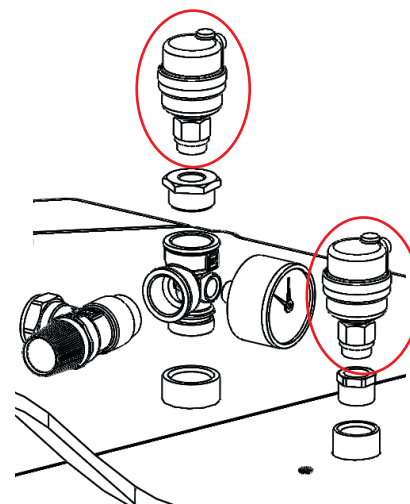

The automatic bleeder is equipped with shut off screws.

! If these instructions are not followed during the installation, operation and maintenance of the system, CTC's liability under the applicable warranty terms is not binding.

i Information in this type of box [i] is intended to help ensure that the product functions optimally.

! Information in this type of box [!] is particularly important for correctly installing and using the product.

2. Safety instructions



Turn off the power with an omnipolar switch before doing any work on the product.



The product must be connected to protective earth.



The product is classified as IPX1. The product must not be rinsed with water.



When handling the product with a hoist ring or similar device, make sure that the lifting equipment, eyebolts and other parts are not damaged. Never stand under the hoisted product.



Never jeopardise safety by removing bolted covers, hoods or similar.



Any work on the product's cooling system should be carried out by authorised personnel only.



Installation and connection in the product must be carried out by a authorised electrician. All piping must be installed according to the applicable requirements.

Service of the product's electrical system must only be carried out by a qualified electrician in compliance with the specific requirements of the national standard for electrical safety.

Replacement of damaged supply cable, must be carried out by the manufacturer or qualified service engineer to avoid risk.



Safety valve check:
-Safety valve for boiler/system to be checked regularly.



The product must not be started if it is not filled with water; instructions are in the "Pipe installation" section.



WARNING: Do not switch on the product if there is a possibility that the water in the heater is frozen.



This device can be used by children from the age of eight years and above and by people with reduced physical, sensory or mental ability or lack of experience or knowledge if they have been taught, either with supervision or with the instructions provided, how to use the device safely and understand the risks involved. Children should not play with the device. Cleaning and maintenance should not be carried out by children without supervision.



If these instructions are not followed when installing, operating and maintaining the system, CTC's commitment under the applicable warranty terms is not binding.

3. Important to remember!

Check the following points at the time of delivery and installation:

3.1 Transportation

Transport the unit to the installation site before removing the packaging. Handle the product in the following manner:

- Forklift.
- Lifting eye that has been fitted to the lifting sleeve on top of the product in the expansion connection.
- Lifting band around the pallet. NB: Can only be used with the packaging on. Remember that the product has a high centre of gravity and should be handled with caution.
- The product must be transported and stored in an upright position.

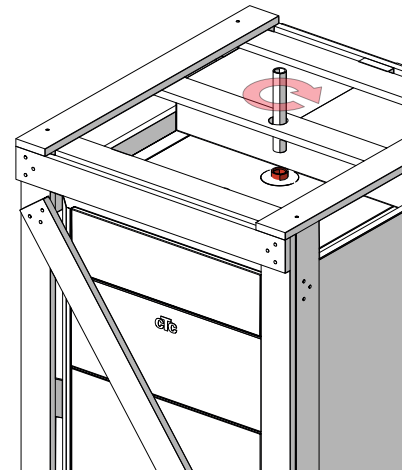

3.2 Positioning

- Remove the packaging and check before installation that the product has not been damaged in transit. Report any transport damage to the carrier.
- Place the product on a solid foundation, preferably made of concrete. If the product needs to be placed on a soft carpet, base plates must be placed under the adjustable feet.
- Remember to leave a service area of at least 1 metre in front of the product.
- The product must not be placed below floor level either.

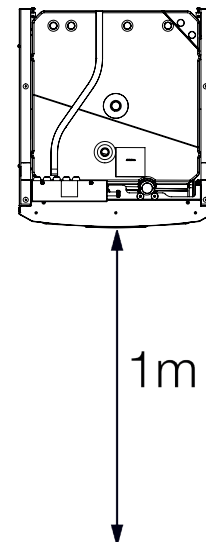

3.3 Recycling

- The packaging must be deposited at a recycling station or with the installation engineer for correct waste management.
- Obsolete products must be disposed of correctly and transported to a waste station or distributor/retailer offering this service. It is very important that the product's refrigerant is disposed of correctly. Disposal of the product as household waste is not permitted.

3.4 After commissioning

- The installation engineer advises the property owner on the design and servicing of the system.
- The installation engineer fills in a checklist and contact information – the customer and installation engineer sign the list, which the customer keeps.
- Register the product for warranty and insurance via the website. <https://www.ctc-heating.com/customer-service#warranty-registration>

4. Your home's heating installation

The House Heating Curve

The heating curve is the central part of the product's control system. It is the heating curve which determines the compensated flow temperature requirements for your property dependent upon the outdoor temperatures. It is important that the heating curve is correctly adjusted, so that you achieve the best operation and economy possible.

One property requires a radiator temperature of 30 °C when the outdoor temperature is 0 °C, whilst a different property requires 40 °C. The difference between different properties is determined by the radiator surface area, the number of radiators and how well insulated the house is.

Adjusting the heating curve

In the "Heating curve" menu under "Settings/Heating circuit", you can fine adjust the values of the heating curve for the primary flow temperature in relation to the outdoor temperature in the graph, as well as set the values for curve inclination and curve adjustment for the heating circuit.

See section "Heating curve" in chapter "Settings/ Heating circuit" for detailed information.

Ask your installer to help you set these values.

It is extremely important to set the heating curve and, in some cases, unfortunately, this process may take several weeks. The best way of doing this, upon the initial start-up, is to select operation without any room sensor. The system then operates using the outdoor temperature reading and the property's heating curve only.

During the adjustment period it is important that:

- the night reduction function is not selected.
- all thermostat valves on the radiators be fully opened. (This is to find the lowest curve for the most economical use of the heat pump).
- the outdoor temperature is not higher than +5 °C.
- the radiator system is operational and correctly adjusted between different circuits.

i For more information on how to set the heating curve, see section "Heating curve" in chapter "Settings / Heating circuit".

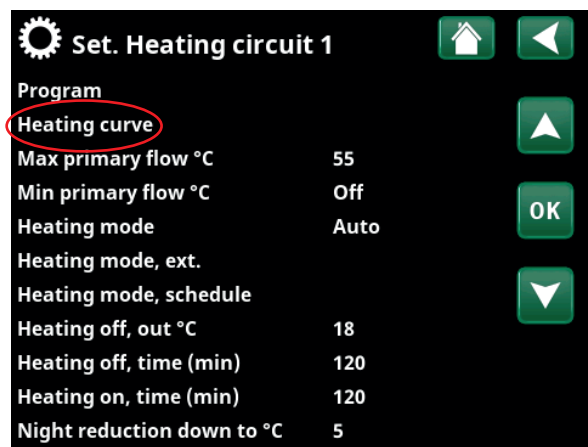

Part of the "Installer/Settings/Heating Circuit/Heating Circuit 1" menu.

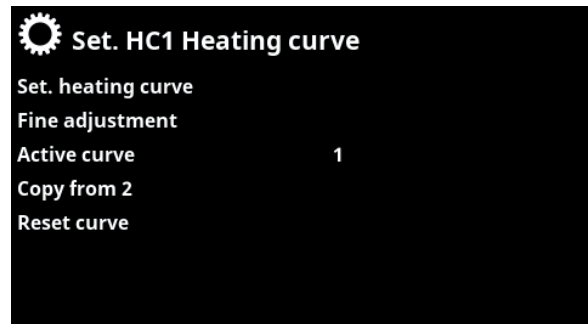

Menu: "Installer / Settings / Heating Circuit / Heating Circuit 1/Heating curve". Active curve: #1.

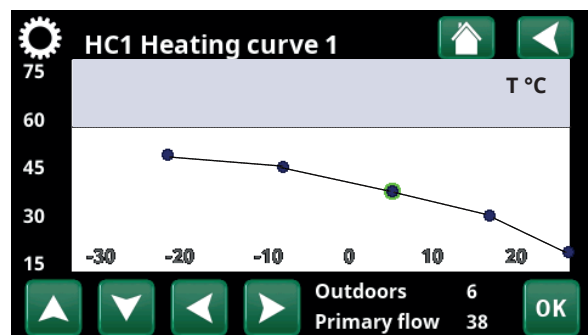

Menu: "Installer / Settings / Heating Circuit / Heating Circuit 1/Heating curve/Fine adjustment".

Appropriate Default Values

During installation you can seldom achieve a precise setting for the heating curve instantly. In this case, the values given below may provide a good starting point. Radiators with small heat-emission surfaces require a higher primary flow temperature. You can adjust the gradient (heating curve gradient) for your heating system under the "Installer / Settings / Radiator system" menu. Recommended values are:

Floor heating only:	Inclination 35
Low temperature system: (well insulated houses)	Inclination 40
Normal temperature system: (factory setting)	Inclination 50
High temperature system: (older houses, small radiators, poorly insulated)	Inclination 60

Adjusting the heating curve

The method described below can be used to adjust the heating curve correctly.

Adjustment if it is too cold indoors:

- If the outdoor temperature is **lower** than 0 degrees:
Increase the Inclination value by a couple of degrees.
Wait 24 hours to see if any further adjustment is required.
- If the outdoor temperature is **higher** than 0 degrees:
Increase the Adjustment value by a couple of degrees. Wait 24 hours to see if any further adjustment is required.

Adjustment if it is too warm indoors:

- If the outdoor temperature is **lower** than 0 degrees:
Decrease the Inclination value by a couple of degrees.
Wait 24 hours to see if any further adjustment is required.
- If the outdoor temperature is **higher** than 0 degrees:
Decrease the Adjustment value by a couple of degrees.
Wait 24 hours to see if any further adjustment is required.



The set heating curve always takes priority. The room sensor can only increase or decrease the heat beyond the set heating curve to a certain extent. Where operating without a room sensor, the selected heating curve determines the flow temperature supplied to the radiators.

Examples of Heating Curves

You can see in the diagram below how the heating curve changes with different Inclination settings. The gradient of the curve shows the temperatures that the radiators require at different outdoor temperatures.

Curve Inclination

The inclination value which is set is the primary flow temperature when the outside temperature is -15°C .

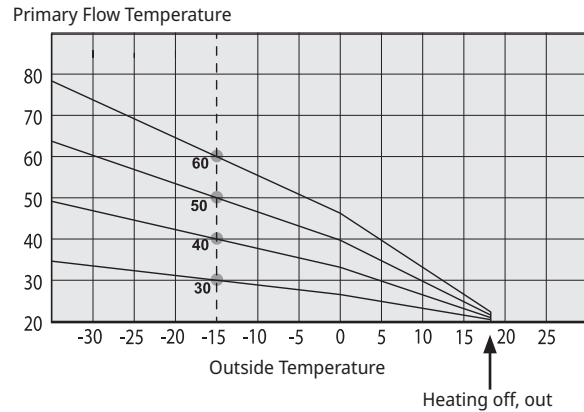

Adjustment

The curve can be parallel displaced (adjusted) by the desired number of degrees to adapt to different systems/houses.

Inclination 50°C
Adjustment $+5^{\circ}\text{C}$

Inclination 50°C
Adjustment 0°C

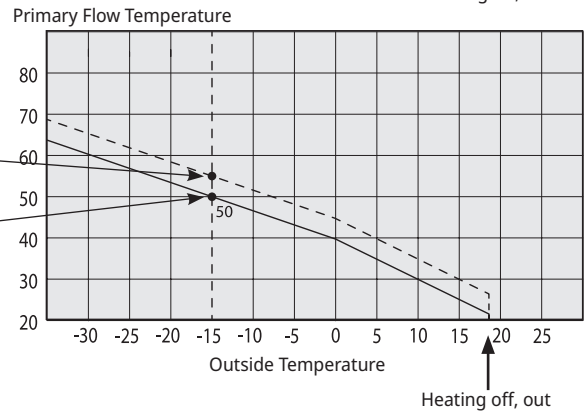

An example

Inclination 60°C
Adjustment 0°C

In this example, the maximum outgoing primary flow temperature is set at 55°C . The minimum permitted primary flow temperature is 27°C (e.g. summer-time basement heating or the floor circuits in a bathroom).

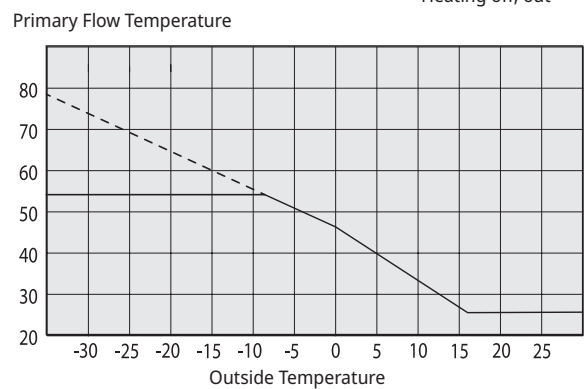

If the values set are too low, this may mean that the desired room temperature is not being reached. You then need to adjust the heating curve, as necessary, following the method shown above.

Summer season

All properties have internal heat gains (lamps, oven, body heat, etc.), which means that the heating can be switched off when the outdoor temperature is lower than the desired room temperature. The better insulated the house is, the earlier the heating from the heat pump can be switched off.

The example shows the product set at the default value of 18°C. This value, "**Heating off, outside**", can be changed in the "Installer/Settings/Heat circuit" menu.

In systems with a radiator pump, the radiator pump stops when the heat is switched off. The heating starts up automatically when it is required again.

See chapter "Settings/Heating circuit" for information on setting the heating mode.

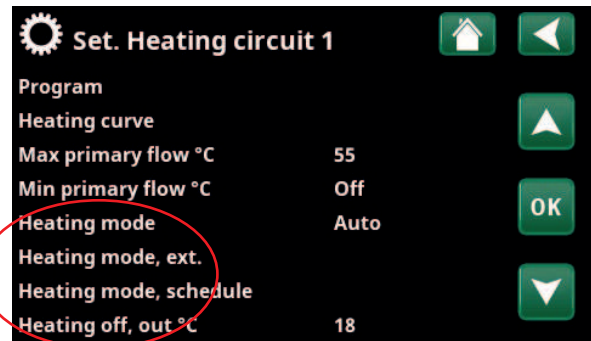
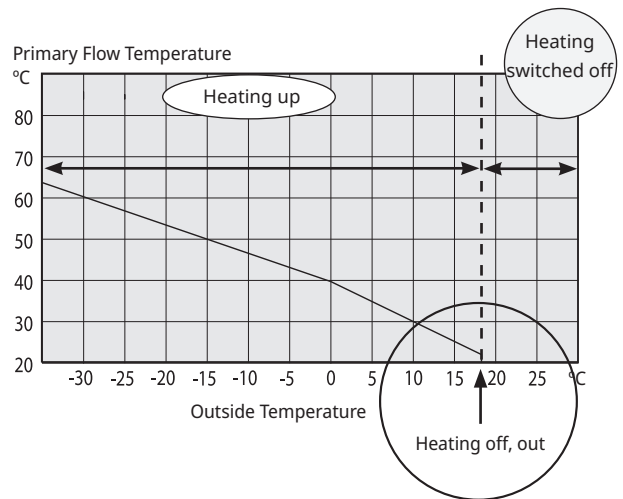

Part of the "Installer/Settings/Heating Circuit/Heating Circuit 1" menu.

5. Technical data

Designation		CTC EcoZenith	CTC EcoZenith	CTC EcoZenith	CTC EcoZenith
General data		i360 L	i360 H	i360 L 1x230V	i360 L 3x230V
Article number		589400001	589401001	589400002	589400003
EAN		7333077094485	7333077094478	7333077094492	7333077094508
Gross weight	kg	172	185	172	172
Net weight	kg	145	156	145	145
Dimensions DxWxH (without packaging)	mm	673x596x1669	673x596x1867	673x596x1669	673x596x1669
Required ceiling height	mm	1669	1928	1669	1669
Sound power L _{WA} (EN 12102)	dB(A)	15	15	15	15
Electrical data					
Connection		400V 3N~ 50Hz	400V 3N~ 50Hz	230V 1N~ 50Hz	230V 3~ 50Hz
Rated power	kW	12.2	12.2	9.3	10.3
Rated current	A	19	19	41	27
Max immersion heater output (@ fuse size)	kW	3.5/6.1/8.4/9.9/11.9 (10/13/16/20/25 A)	3.5/6.1/8.4/9.9/11.9 (10/13/16/20/25 A)	3.8/5.2/6.7/7.5/9/9 (20/25/32/35/50/63 A)	5/7.5/10/10/10/10 (20/25/32/35/50/63 A)
Ingress Protection (IP)		IP X1	IP X1	IP X1	IP X1
Power for each step for electrical element	kW	0/0.5/1/1.5/2/2.5/ 2.8/3/3.3/3.5/3.8/ 4.3/4.8/5.3/5.6/5.8/ 6.1/6.3/6.6/7.1/ 7.6/8.1/8.4/8.6/8.9/ 9.1/9.4/9.9/10.4/ 10.9/11.4/11.9	0/0.5/1/1.5/2/2.5/ 2.8/3/3.3/3.5/3.8/ 4.3/4.8/5.3/5.6/5.8/ 6.1/6.3/6.6/7.1/ 7.6/8.1/8.4/8.6/8.9/ 9.1/9.4/9.9/10.4/ 10.9/11.4/11.9	0/0.3/0.6/0.9/1.2/ 1.5/1.8/2.1/2.3/ 2.6/2.9/3.2/3.5/3.8/ 4.1/4.4/4.6/4.9/5.2/5.5/5. 8/6.1/6.4/6.7/6.9/ 7.2/7.5/7.8/ 8.1/8.4/9	0/2.5/5/7.5/10

Heating medium system					
Water volume (V) (PED)					
Max operating pressure (PS) (PED)	MPa/ Bar	0.3/ 3.0	0.3/ 3.0	0.3/ 3.0	0.3/ 3.0
Max operating temperature (TS) (PED)					
Max adjustable operating temperature	°C	70	70	70	70
Product Kvs value					
Pressure differential diagram for product including exchanger and all internal pipes, valves etc.	kPa	See pressure differential diagram in section "System adjustment"	See pressure differential diagram in section "System adjustment"	See pressure differential diagram in section "System adjustment"	See pressure differential diagram in section "System adjustment"
Built-in circulation pump		Yes	Yes	Yes	Yes

		CTC EcoZenith i360 L	CTC EcoZenith i360 H	CTC EcoZenith i360 L 1x230V	CTC EcoZenith i360 L 3x230V
Hot tap water system					
Water volume (V) (PED)	l	1.7	1.7	1.7	1.7
Max operating pressure (PED)	Bar	10	10	10	10
Max operating temperature (TS) (PED)	°C	100	100	100	100
DHW performance according to prEN 16147					
		Economy	Normal	Comfort	
Quantity of hot water (40°C)	l	210	235	304	
Load profile *)		XL	XL	XL	XL

*) according to Regulation (EU) no. 813/2013

6. Measurements

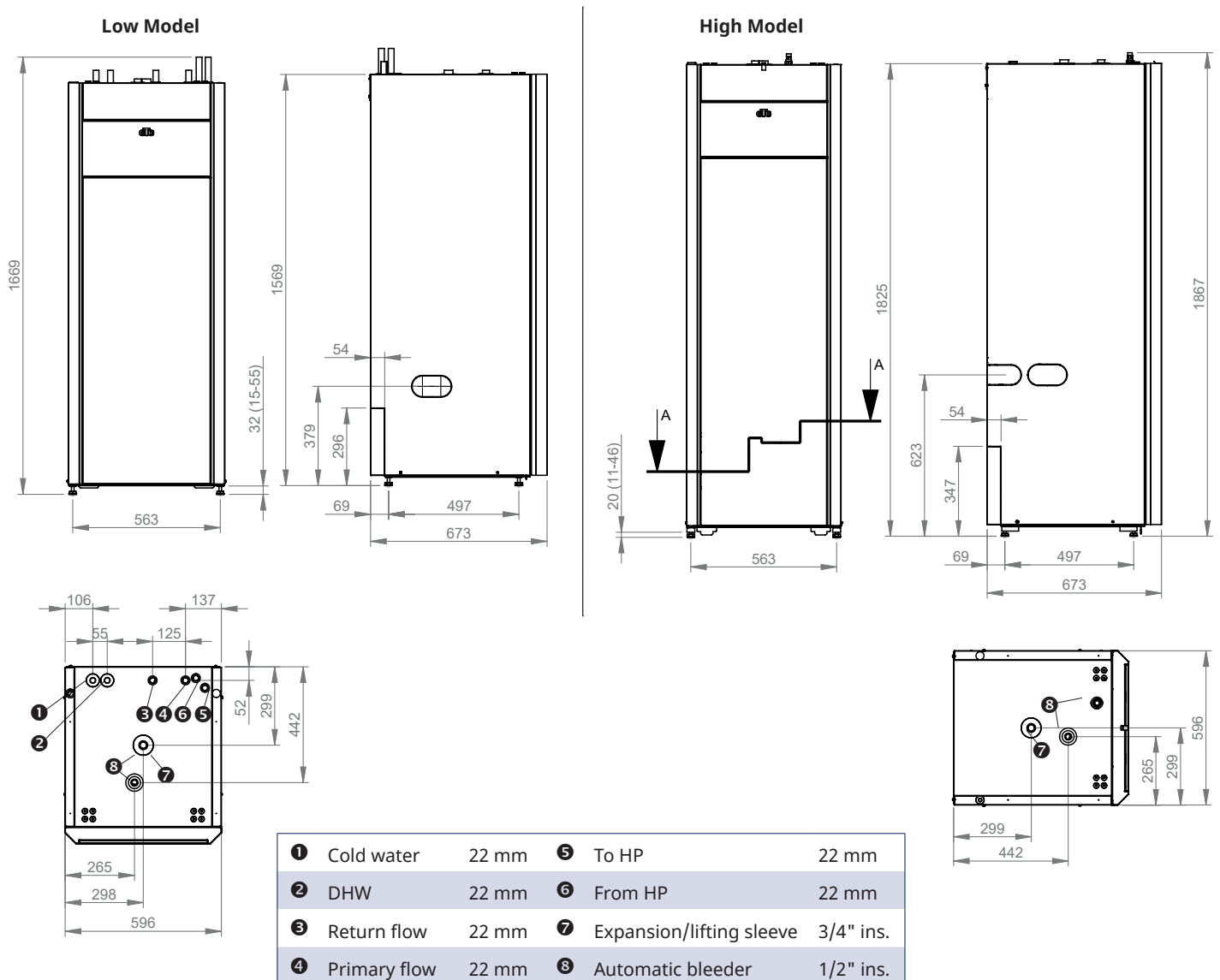

7. Overview CTC EcoZenith i360

The picture below shows the basic construction of CTC EcoZenith i360.

If a heat pump is connected, the energy in the air or bedrock/ground is drawn up by the cooling system. The compressor then increases the temperature to a usable level. Afterwards it releases the energy for the heating circuit and DHW. The built-in immersion heater helps when additional heat is needed or when a heat pump is not connected.

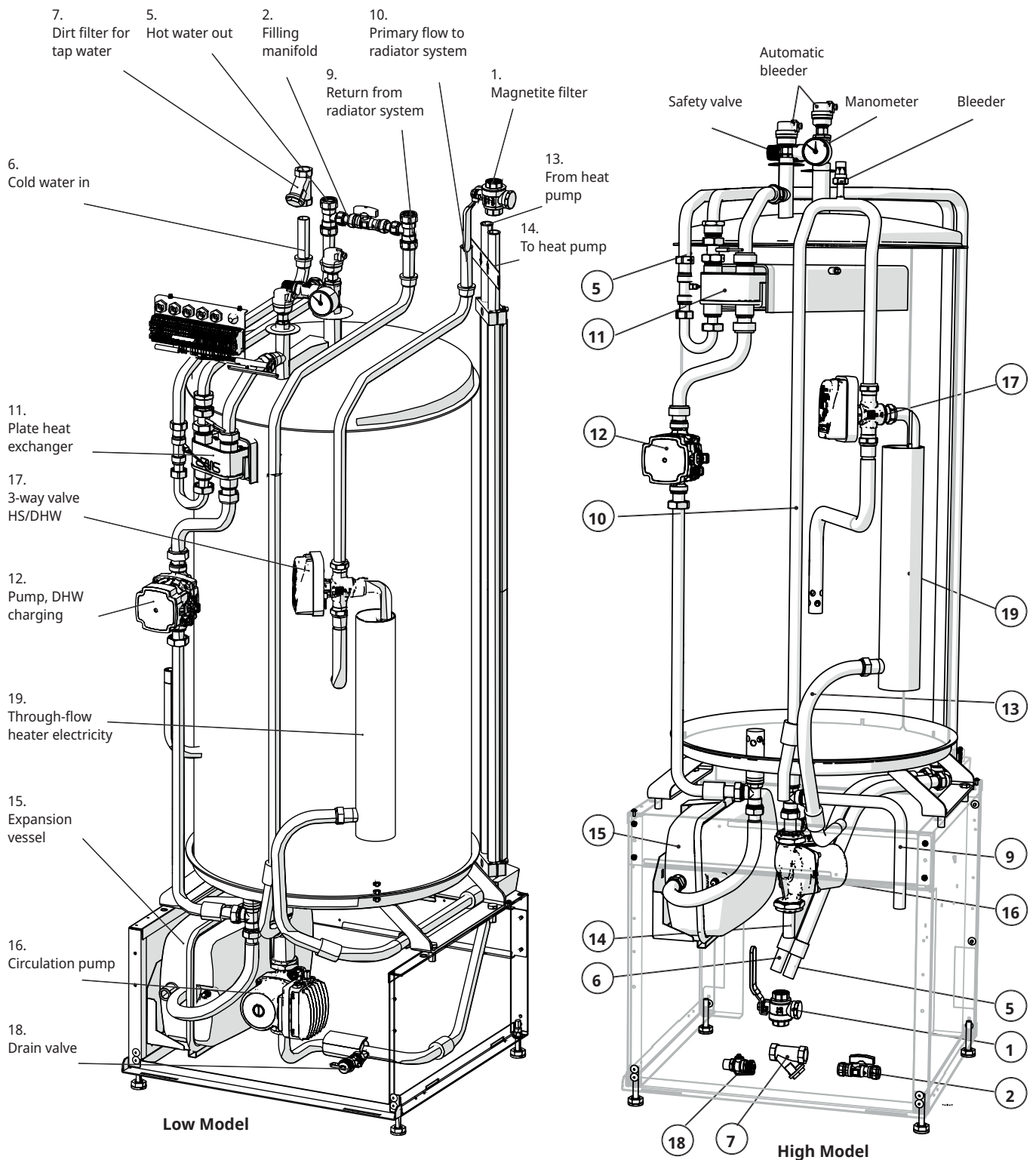

16290526-1

7.1 Options with CTC EcoZenith i360

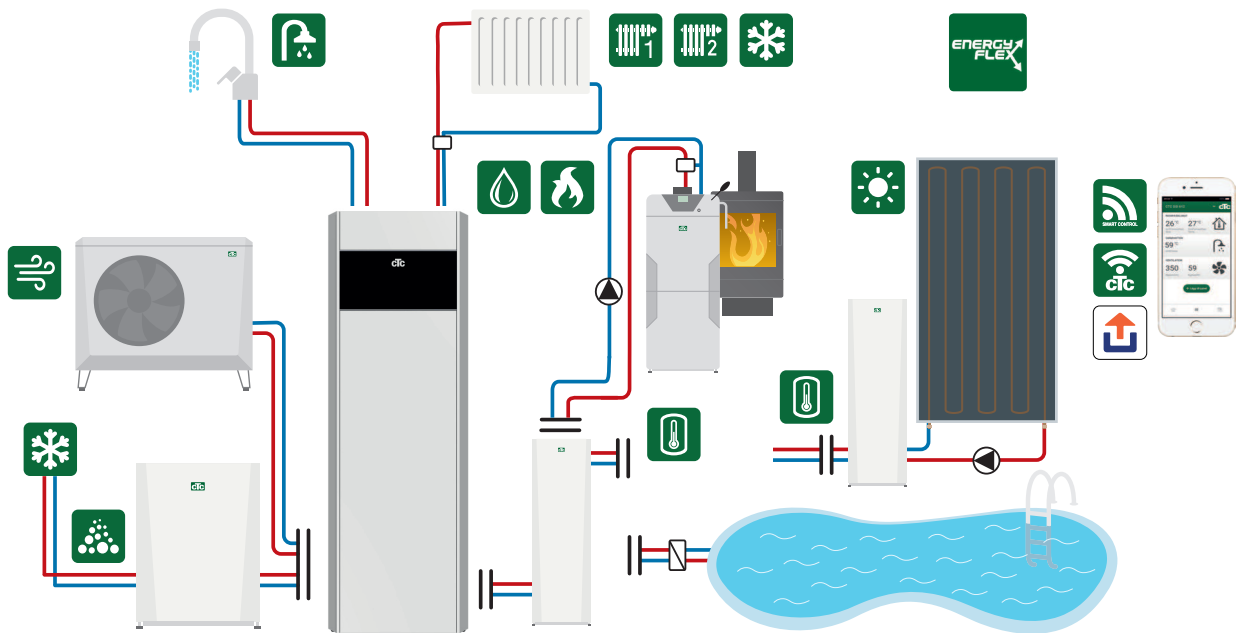

In addition to the basic installation, accessories are required such as: Extra sensor, Mixing Valve group 2, Expansion Card, etc. CTC Volume tank is recommended for large heating needs or for systems with a high pressure differential. See chapter "System adjustments".

7.2 Basic installation, CTC EcoZenith i360

EcoZenith i360
1 heating circuit
1 compatible EcoAir/CombiAir heat pump

EcoZenith i360
1 heating circuit
1 compatible EcoPart heat pump

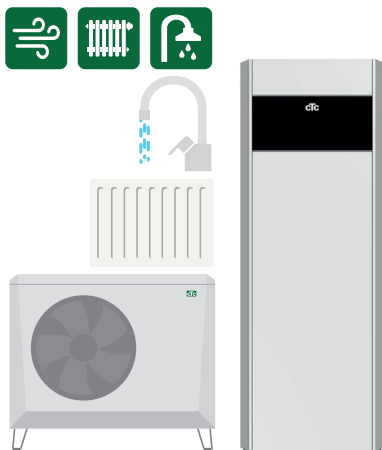

EcoDesign information and energy labelling stickers about the current combination (current package) can be retrieved/downloaded from www.ctc.se/ecodesign. Information and energy labelling stickers must be handed over to the final consumer of the package in question.

7.3 Compatible heat pumps

CTC EcoPart 400
Brine to water

- CTC EcoPart 406
- CTC EcoPart 408
- CTC EcoPart 410
- CTC EcoPart 412

CTC EcoPart 600
Speed controlled,
Brine to water

- CTC EcoPart 612*
- CTC EcoPart 616*

CTC EcoAir 400
Air-to-water

- CTC EcoAir 406
- CTC EcoAir 408

CTC EcoAir 500M/600M
Speed controlled
Air-to-water

- CTC EcoAir 510M
- CTC EcoAir 610M
- CTC EcoAir 614M
- CTC EcoAir 622M

CTC CombiAir 6-16M
Speed controlled
Air-to-water

(from software version
2021-01-01)

- CTC CombiAir 6M
- CTC CombiAir 8M
- CTC CombiAir 12M
- CTC CombiAir 16M

CTC CombiAir MR
Speed controlled
Air-to-water

(from software version
2023-11-01)

- CTC CombiAir 6MR
- CTC CombiAir 10MR

CTC EcoAir 700M
Speed controlled
Air-to-water

(from software version
2023-11-01)

- CTC EcoAir 708M
- CTC EcoAir 712M

7.4 Delivery includes:

- CTC EcoZenith i360.
- Installation and Maintenance Manual.
- Supplied Components (list and picture below of supplied components for CTC EcoZenith i360).

No.	Designation	**Quantity
1	Outdoor sensor	1/1/1/1
2	Room sensor	1/1/1/1
3	Safety valve 2.5 bar 3/4" ext.	1/1/1/1
4	Support sleeve 22x1	4/5/4/4
5	Filter ball valve with magnet	1/1/1/1
6	Dirt filter 3/4" int. 0.4 mm	1/1/1/1
7	Current sensor	3/3/0/3
8	Manifold	1/1/1/1
9	Automatic bleed valve	2/2/2/2
10	Bushing 3/4"x3/8"	1/1/1/1
11	Manometer	1/1/1/1
12	Filling valve	1/1/1/1
13	T-connection 22-15-22	2/2/2/2
14	Filler pipe cu15	2/1/2/2
15	Filler pipe cu15	0/1/0/0
16	Drainage valve 1/2"	0/1/0/0
17	Bleeding instructions	1/1/1/1
18	Installation instructions for bleeding and filling EZi360	1/1/1/1
19	Bushing 1/2"x3/8"	1/1/1/1

**CTC EcoZenith i360: L (3x400V) / H (3x400V) / L 1x230V / L 3x230V

! * NOTE!
When the CTC EcoPart 600 is controlled by the CTC EcoZenith i360, the heat pump's factory-fitted charge pump will not be used.

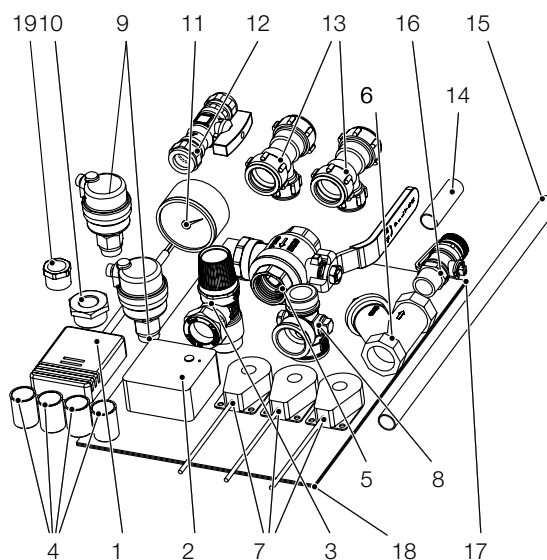

8. Pipe installation

The installation must be carried out in accordance with the applicable standards. **Do not forget to flush the heating circuit clean before connecting.** Apply all the installation settings based on the description in the section entitled "First start".

In order to adjust the pressure in the expansion vessel and check the pipe fittings before the first start, the front needs to be dismantled.

1. Remove magnetic strip.
2. Loosen two screws.
3. Fold out front.
4. Lift up and out front.
5. Beware of cable between display and cabling.

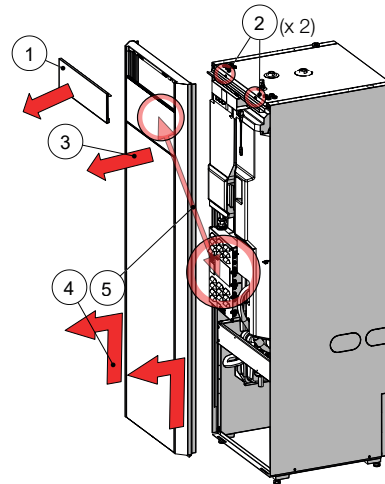

! Minimum water volume in the heating circuit (>25 °C) for reliable defrosting functionality:

EcoAir 610M	80 l
EcoAir 614M	80 l
EcoAir 622M	120 l
EcoAir 406	80 l
EcoAir 408	100 l
EcoAir 510	50 l
1x230 V	
CombiAir 6M	20 l
CombiAir 8M	50 l
CombiAir 12M	80 l
CombiAir 16M	150 l

8.1 Schematic diagram for air-to-water heat pump

EcoZenith i360

1 heating circuit

1 compatible CTC EcoAir heat pump from the 400, 500 or 600 series.

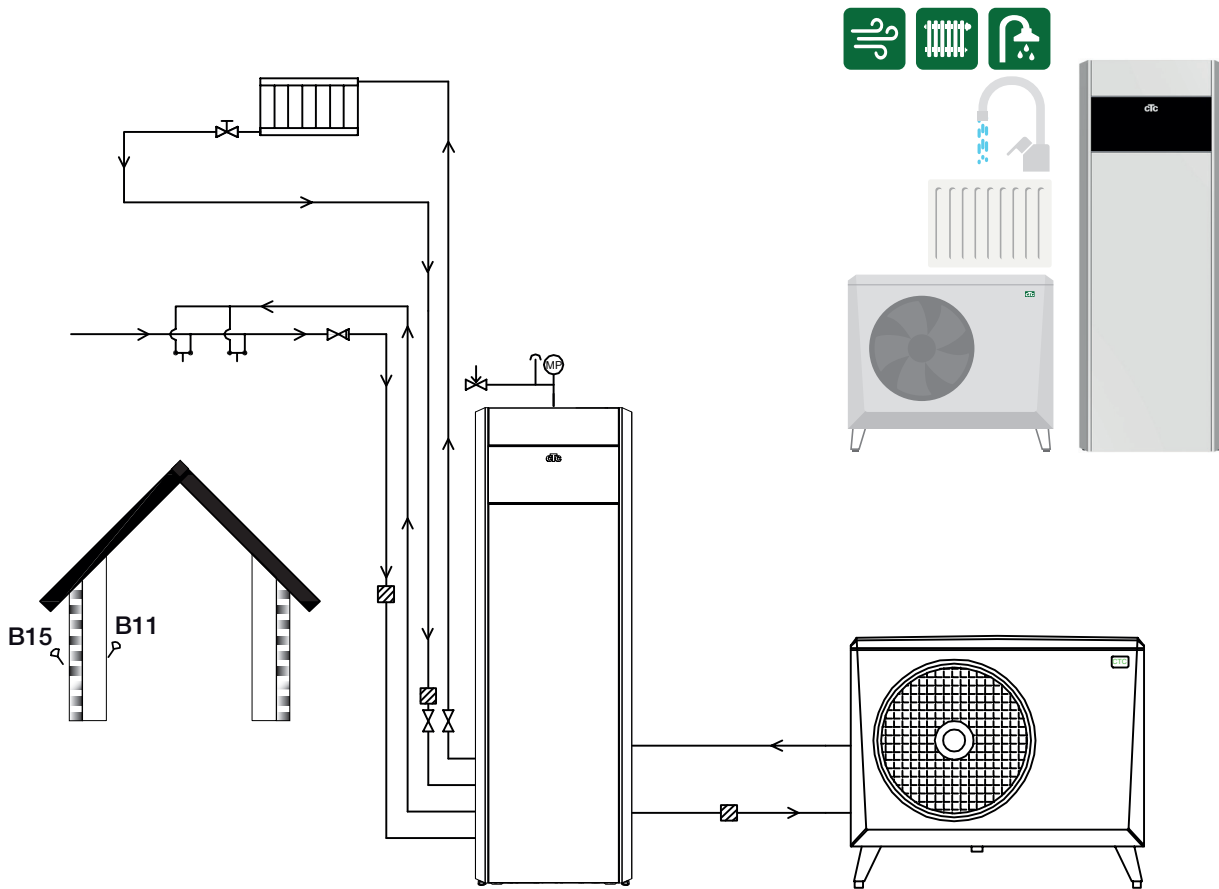

8.2 Schematic diagram for brine-to-water heat pump

CTC EcoZenith i360
1 heating circuit
1 compatible heat pump from the CTC EcoPart 400 or 600 series.

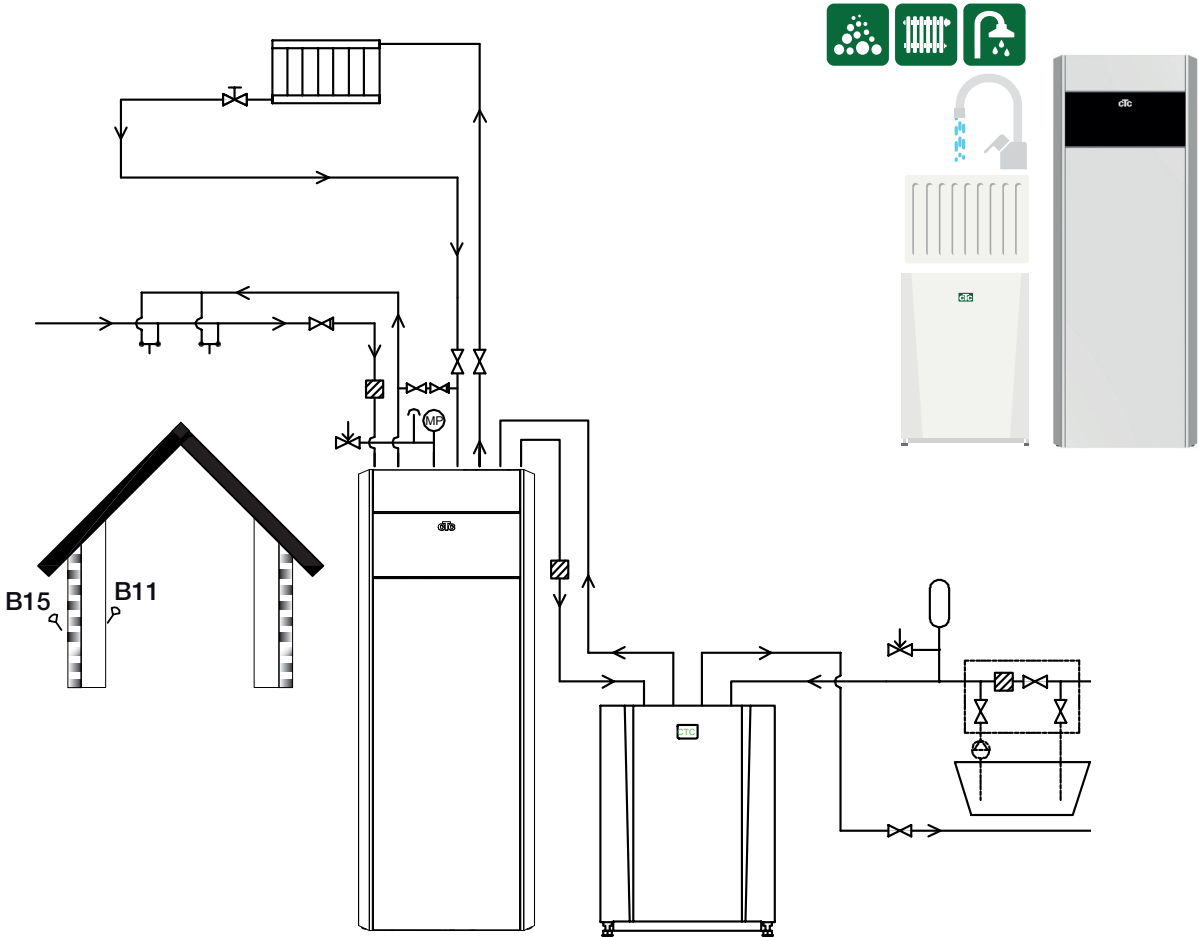

8.3 Full schematic diagram

This is a full schematic diagram of the connection options for the CTC EcoZenith i360. Different installations and systems may look different, e.g. a one or two-pipe system, which means that the finished installation may be different.

In addition to basic installation

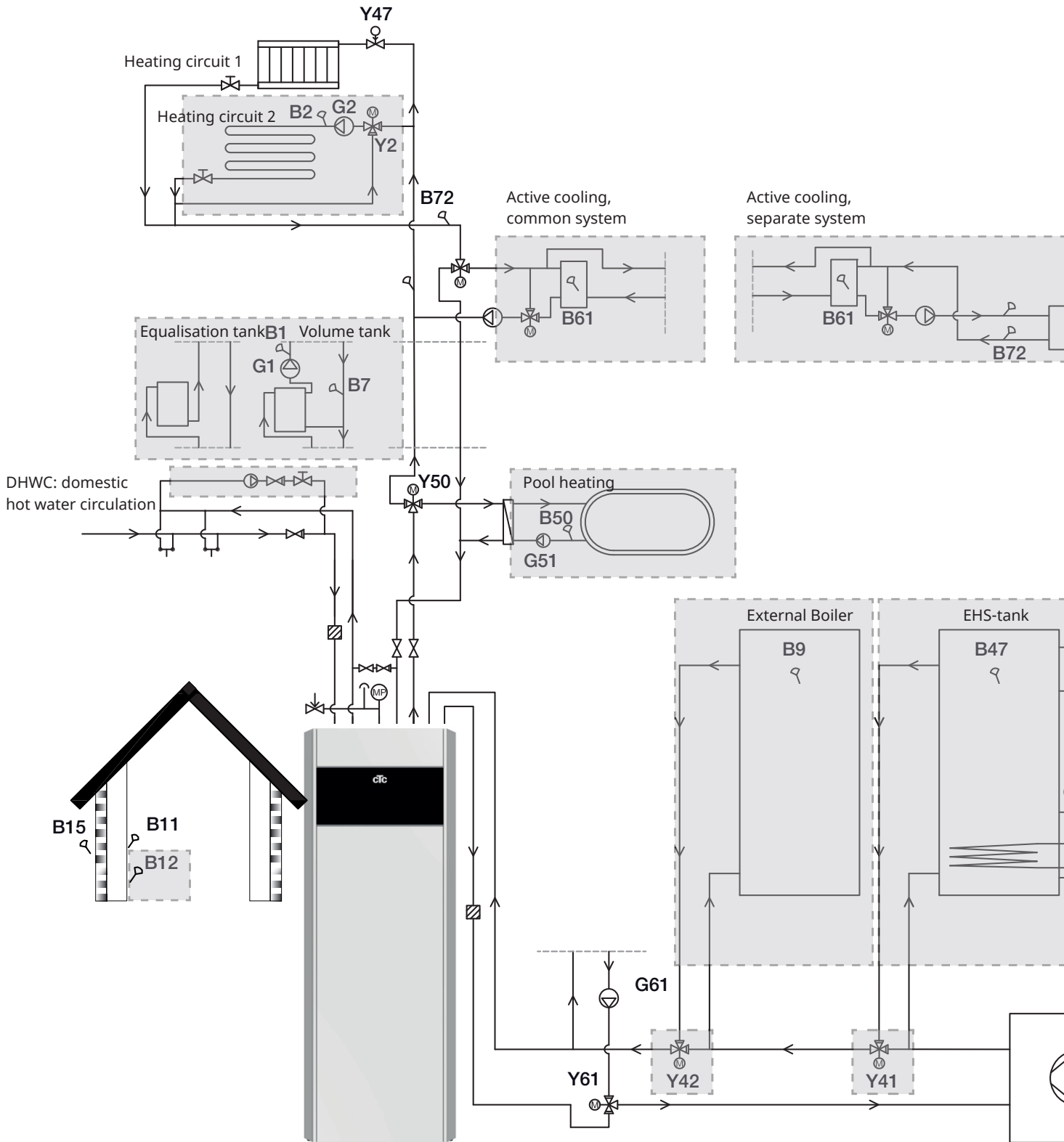

8.4 Interactive schematic diagram

On CTC's website, you can bring up and print out the schematic diagram for the installation you want by clicking the option in the interactive pdf file.

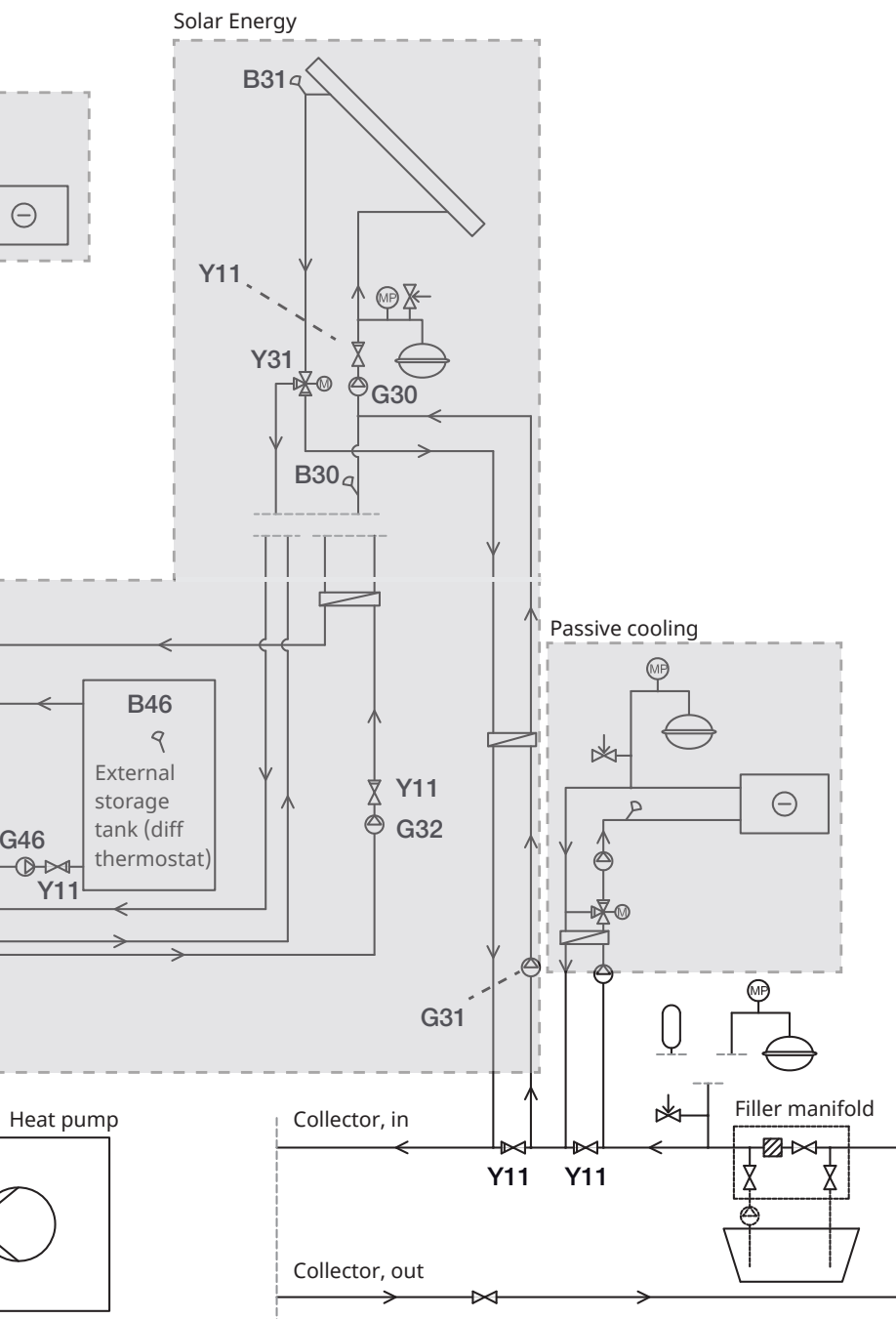

	Mixing valve
	Diverting valve
	Control valve
	Solenoid valve
	Non-return valve
	Shut-off valve
	Sensor
	Pump
	Dirt filter
	Pressure sensor
	Safety valve
	Level vessel
	Expansion tank
	Heat exchanger

8.5 Install hot water pipe

DHW

- 5.5.1 Install dirt filter.
 - 5.5.2 Install cold water supply with non-return valve.
 - 5.5.3 Install the filling valve.
 - 5.5.4 Install hot water pipe from tank.
- Check function – flush.

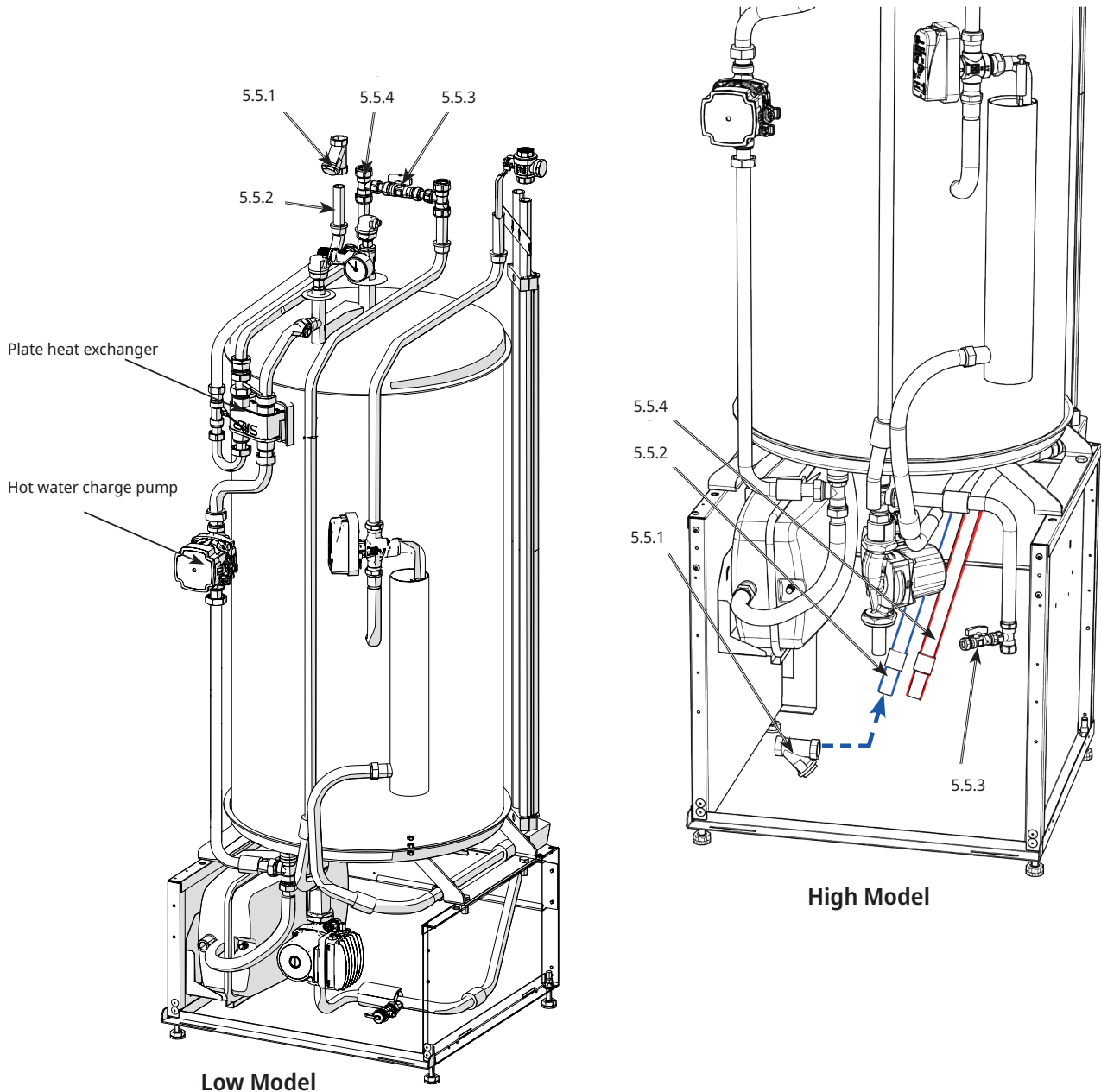

NB: To facilitate servicing, it is important to fit shut-off valves to both the primary flow and the return line.

8.6 Install pipe for radiator system

Heating circuit

- 5.6.1 Install primary flow with shut-off valve.
- 5.6.2 Install return line.

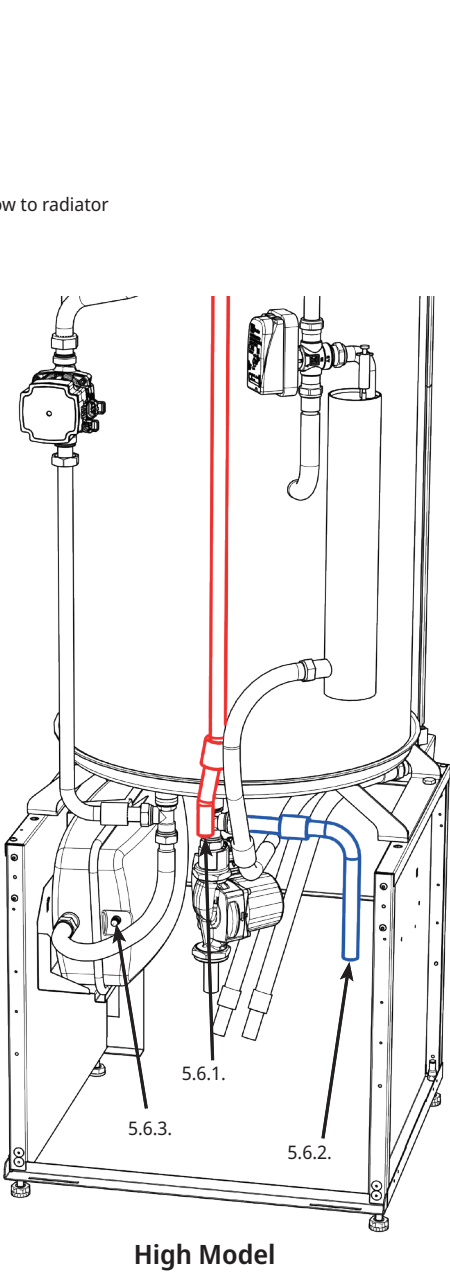
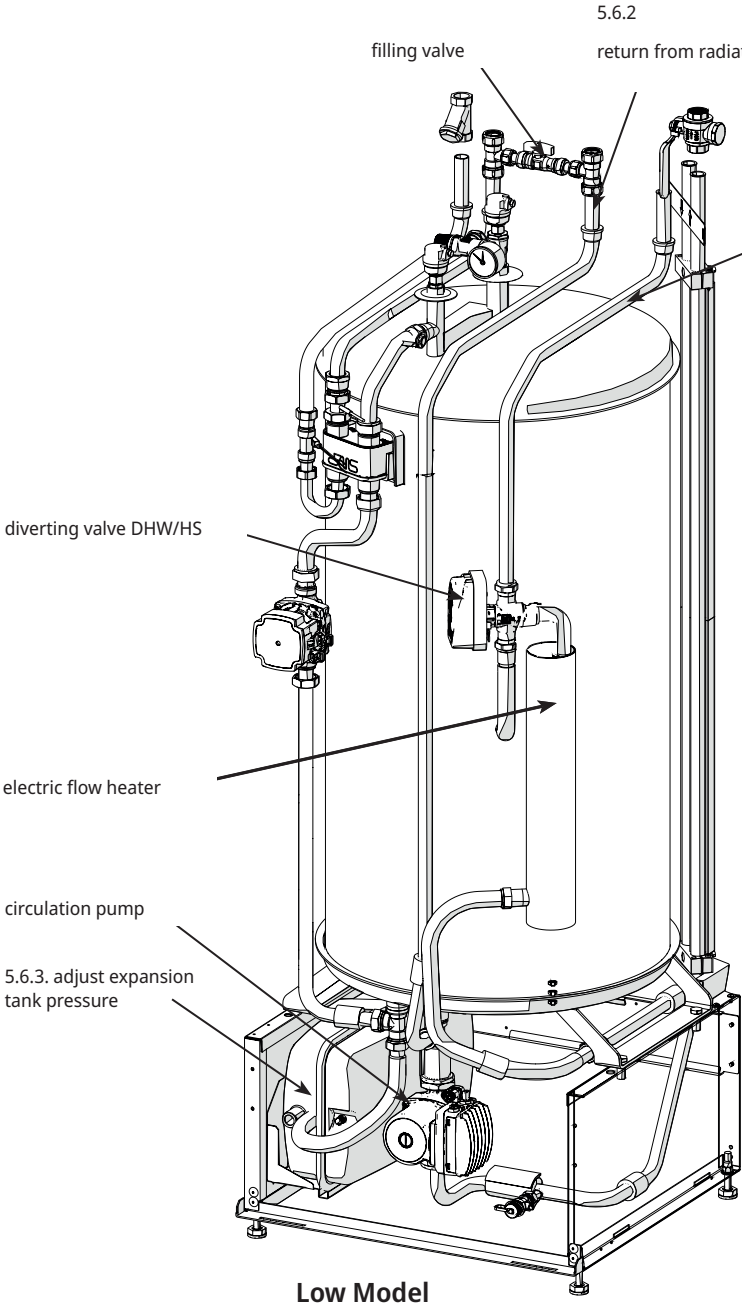

! NB: To facilitate servicing, it is important to fit shut-off valves to both the primary flow and the return line.

5.6.3 Adjust the pre-assembled expansion tank to the right pre-pressure by using the valve to raise or lower the pressure.

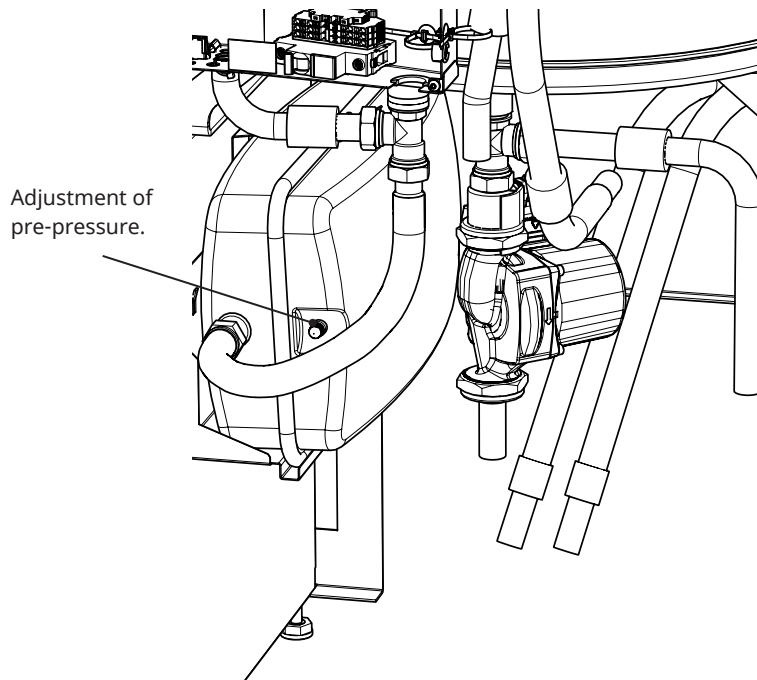

The pre-pressure in the expansion tank is calculated according to the height (H) between the highest-positioned radiator and the expansion tank. The pre-pressure must be checked/set before the system is filled with water. The system pressure must be set 0.3 bar higher than the pre-pressure in the expansion tank. For example, a pre-pressure of 1.0 bar (10 mvp) means a maximum permitted height difference of 8 m.

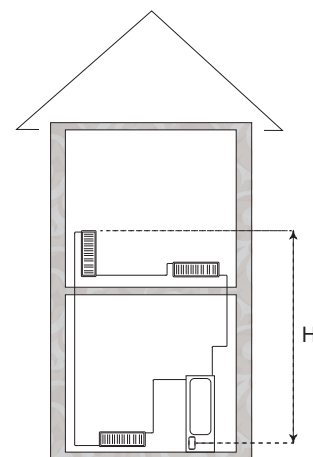

Maximum height (H) (m)	Pre-pressure (bar)	Maximum volume in the heating circuit (excluding product) (L)
3	0.5	240
8	1.0	85

- ! The expansion tank provided is pre-pressurised to approx. 1 bar, and therefore needs to be adjusted to a suitable pre-pressure for the building. This must be done before the system is filled with water.
- If an open expansion tank is used, the distance between the expansion tank and the highest placed radiator must not be below 2.5 m, in order to avoid introducing oxygen into the system.
- If a heat pump is connected with another heat source, e.g. an existing boiler, the installations must have separate expansion vessels.

8.7 Install pipes to and from the heat pump

Heat pump

5.7.1 Install pipe to the heat pump with solenoid filter ball valve.

5.7.2 Install pipes from heat pump.

Install any adjustable by-pass coupling past the heat pump. (*a by-pass coupling is only used for electric operation without a heat pump).

* without a heat pump, to and from heat pump must be connected.

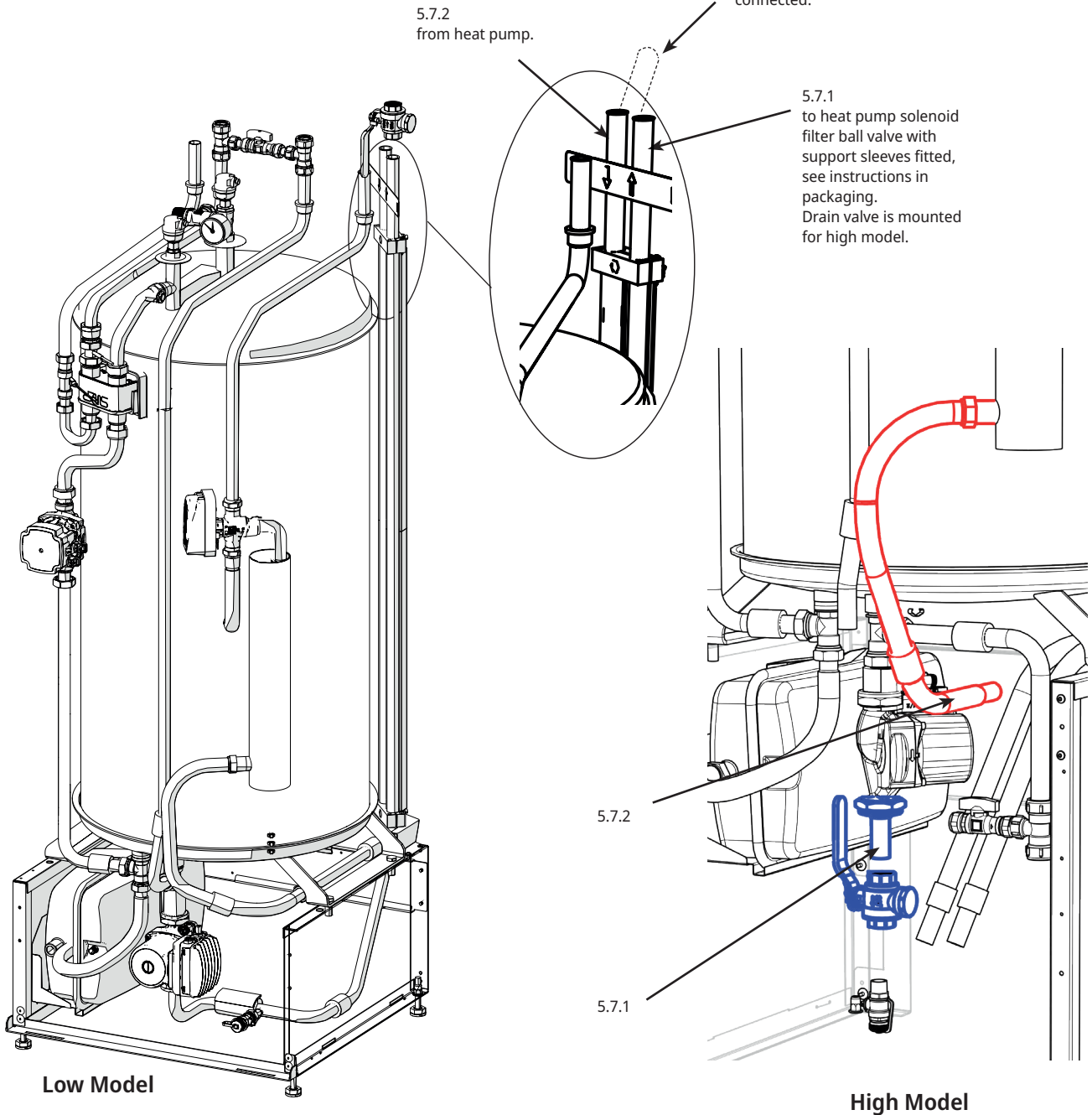

CTC EcoZenith i360 is only approved for installation together with CTC Heat pumps. See the recommended systems at the start of the installation instructions.

8.8 Install waste water piping

Waste water

5.8.1 Fit the safety valve, bleed valve and manometer. Components and assembly instructions are included in the additional pack for the product.

5.8.2 Install waste water piping.

5.8.3 The bleed valve is activated by loosening the bleeder screw, which should then be closed after a few minutes.

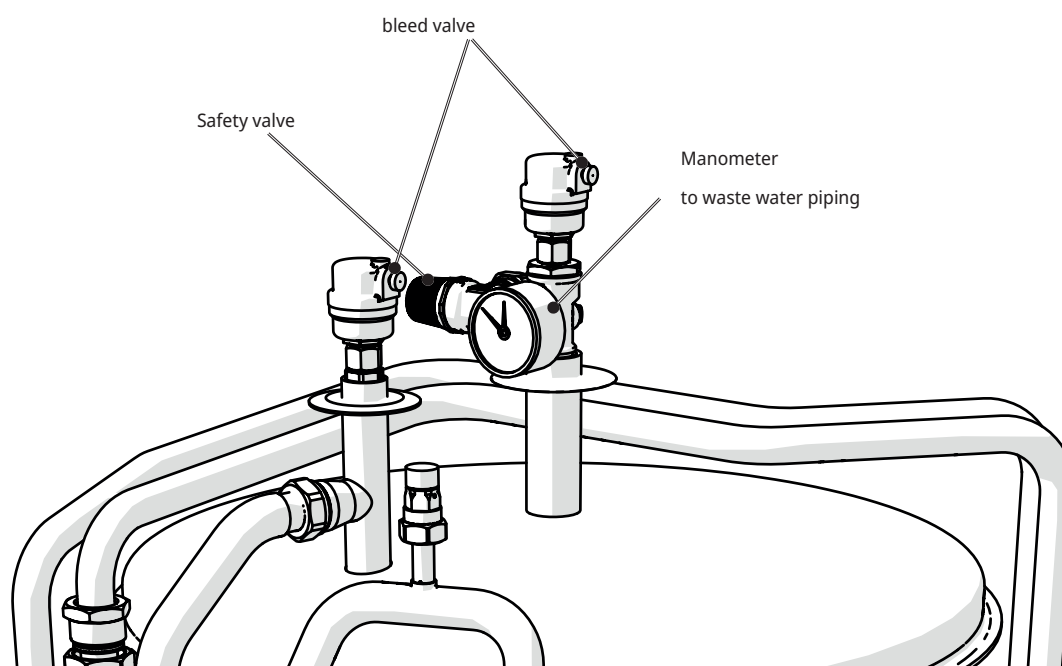

High Model



NB: Safety valve

The tank's safety valve (2.5 bar) for the heating circuit must be fitted in accordance with applicable regulations. The waste pipe is connected to the waste system, either directly to the floor drain or via a funnel. The waste pipe must slope towards the waste system, be installed frost-free and left open to the atmosphere/without pressure. The waste pipe must be fitted to the waste system.

8.9 Fill the heating circuit

Fill the heating circuit

5.9.1 Open the filling valve and fill the heating circuit.

5.9.2 Turn the safety valve to release air more quickly during filling; close the filling valve when the system is full.

5.9.3 Check the manometer for a filled cold system (approx. 1 bar or 0.2-0.3 bar above the pre-pressure on the expansion tank).

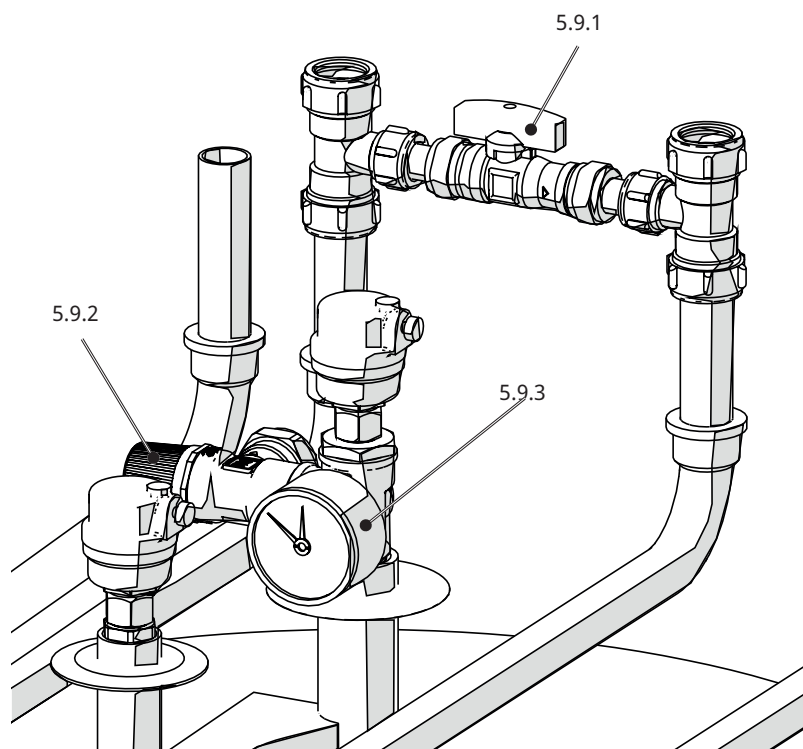

Low Model

8.10 Bleed the entire system

Bleed the system

5.10.1 Bleed the CTC EcoZenith i360 valve using the safety valve, make sure also that the screw for the automatic bleed valve has been activated.

5.10.2 Bleed, activate bleed valve for heat pump.

5.10.3 Bleed high points for the radiator system.

5.10.4 Flush the hot water system.

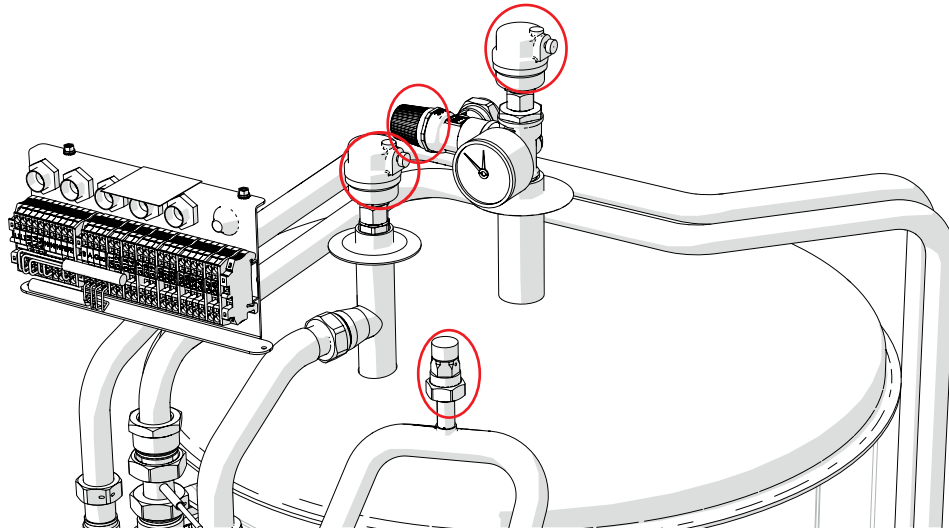

High Model



Bleeding is very important for the product to function. Problems that can be resolved by bleeding are listed in the chapter "troubleshooting".

9. Electrical installation

Safety information

The following safety instructions must be observed when handling, installing and using the product:

Turn off the power with an omnipolar switch before doing any work on the product.

- The product is classified as IPX1. The product must not be rinsed with water.
- Never jeopardise safety by removing bolted covers, hoods or similar.
- Never jeopardise safety by deactivating safety equipment.
- Damaged feed cables must be replaced by the manufacturer or a qualified service engineer in order to avoid any risks.
- Installation and heat pump connection must be performed by an authorised electrician. All wiring must be installed according to applicable provisions. The boiler's internal wiring is installed at the factory.

To open the front panel: 1. Remove magnetic strip 2. Loosen two screws 3. Fold out front 4. Lift up and out front 5. Beware of cable between display and cabling.

Supply

The power supply cable is connected at (1). Length 200 cm. The group fuse is selected such that all relevant requirements for the electrical installation is met; see technical data. The size of the fuse is set in the installation flow on the touchscreen. The product adjusts the electrical power according to this. Once a current sensor has been installed, the built-in load switch is able to regulate the immersion heater's electrical output based on the set main fuse.

Omnipolar switch

The installation should be preceded by an omnipolar switch according to overvoltage category III, which ensures disconnection from all electric power sources.

Residual current device

If there is already a residual current device for the building, the product still needs to be fitted with its own residual current device.

Max thermostat

If the product has been stored in an extremely cold place, the max. thermostat may have been triggered. It can be reset by pressing the button on the electrical switchboard behind the front panel. Always check on installation that the max thermostat has not tripped.

Extra low voltage protection

The following outputs and inputs have extra low voltage protection/potential free input: current transformer, outdoor sensor, room sensor, primary flow sensor, return sensor, NR/SO, communication to heat pump.

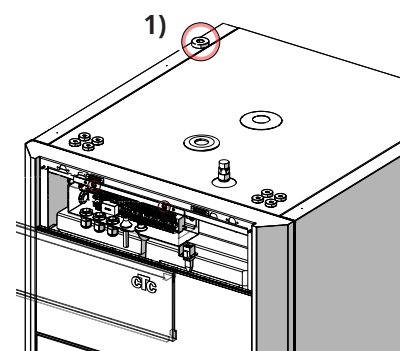
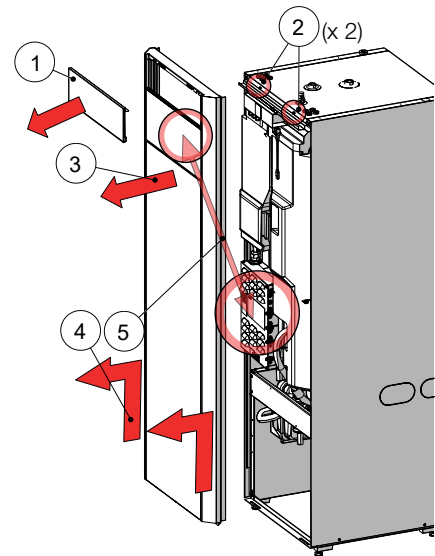

Positioning of supply cable.

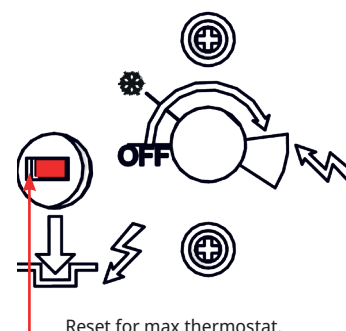

Reset for max thermostat.

9.1 Overview of basic electrical installation

Basic installation includes:

EcoZenith i360
1 heating circuit
1 CTC EcoAir heat pump in the 400, 500, 600M or 700M series.

CTC EcoZenith i360
1 heating circuit
1 heat pump in the CTC EcoPart 400 or 600M series.



In such cases, workflow points 1–6 can be used for electrical installation.

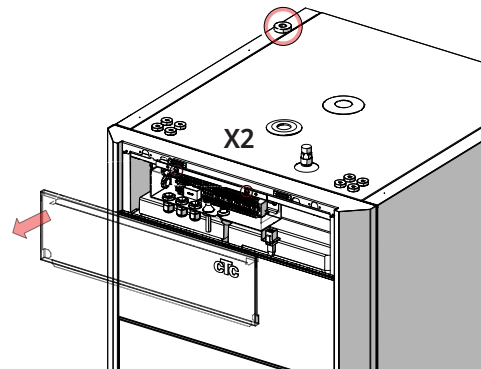

1	2	3	4	5	6
Install fuse panel	Current sensor fitted*	Fit outdoor sensor	Fit room sensor*	Connect heat pump	Finish electrical installation
Omnipolar switch	Fit on fuse panel	Place representatively for outdoor temperature	Place representatively for house temperature	Connect communication cable, terminal block X2	Provide information on house fuse size to pipe installation engineer
Connect factory-fitted feed cable	Connect to terminal block X2	Connect to terminal block X2	Connect to terminal block X2	Connect external power supply to heat pump	Check and sign electrical installation checklist

* option – can be selected

9.2 List of functions

Function	Relay card [A]	Sensor [B]	Pump [G]	Valve [Y]	Fan	Other
Basic installation	(A2) (X2)	B11, B15, (B18), B103	(G5), (G11)	Y21		COM HP – HP A1*
Return temp., installation without HP A1	(A2)	B7				
Heating circuit 2	(A2)	B2, B12	G2	Y2		
Ventilation	(X2)				M40	
Passive cooling	(A2)	B2	G2			
Active cooling	(A2)	B61, B72	G61	Y61		
Volume tank (HS circulation under DHW/Pool)	(A2)	B1	G1			
Electric shut-off valve	(A2)			Y47		
DHW circulation	A3		G40			
External heat source (EHS)	(A2) or A3	B47		Y41		
External Boiler	(A2) or A3	B9		Y42		E1
Diff thermostat function	A3	B46	G46			
Pool	A3	B50	G51	Y50		
Solar Energy	A3	B30, B31	G30	Y30		
Solar energy, bore hole charging	A3		G31	Y31		
Solar energy, intermediate heat exchanger	A3		G32	Y30		
SmartGrid	(A2)					K22–K25
Remote control	(A2)					K22–K25

(Factory-fitted)

*powered separately (not from this unit)

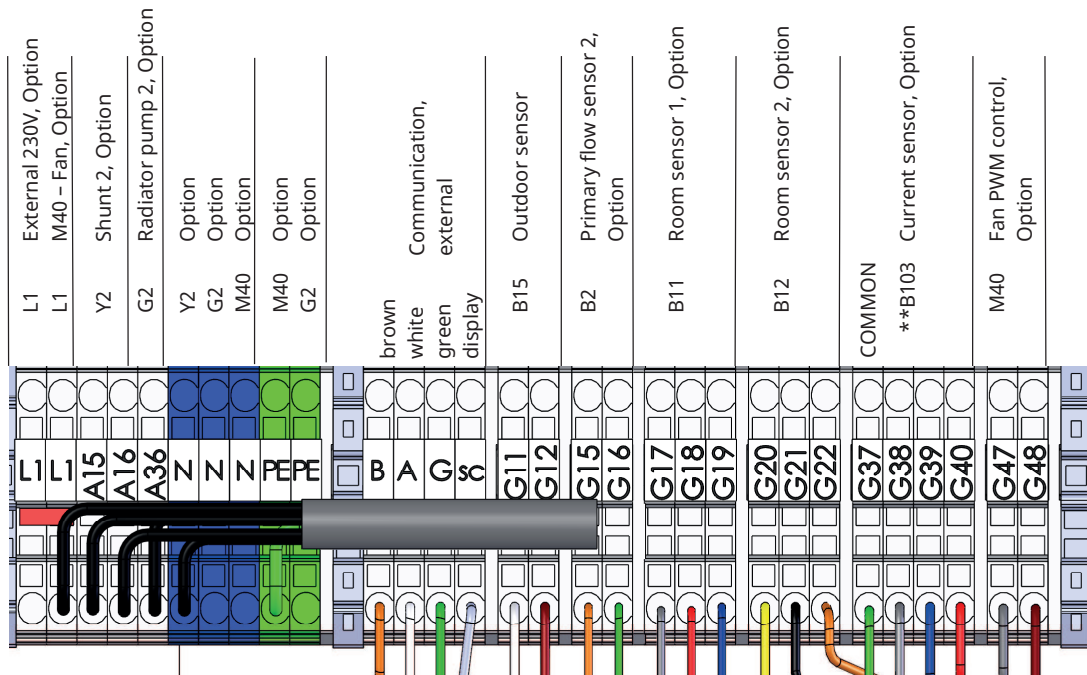

Terminal block X2

**B103 – current sensor not applicable to 1x230V

9.3 Electrical parts list

Designation	Spec	
A1	Display	
A2	Relay/main card	
A3	Expansion card	
A6*	Gateway	
B1	Primary flow sensor 1	NTC 22K
B2	Primary flow sensor 2	NTC 22K
B5	Sensor, DHW tank	NTC 22K
B7	Return sensor	NTC 22K
B9	External boiler sensor	NTC 22K
B11	Room sensor 1	NTC 22K
B12	Room sensor 2	NTC 22K
B15	Outdoor sensor	NTC 150
B18	Primary flow sensor	NTC 22K
B25	DHW sensor	NTC 015 WF00
B26	Sensor, upper hot water tank	NTC 22K
B30	Solar panel sensor in	PT 1000
B31	Solar panel sensor out	PT 1000
B41	Sensor, external buffer tank upper	NTC 22K
B42	Sensor, external buffer tank lower	NTC 22K
B46	Sensor, diff. thermostat	NTC 22K
B47	Sensor, EHS-tank	NTC 22K
B50	Sensor, pool	NTC 22K
B61	Sensor, cooling tank	NTC 22K
B72	Return sensor, active cooling	NTC 22K
B102	Flow switch	
B103	Current sensor	
E1	Relay, additional heating	
F1	Automatic circuit breaker	
F2	Automatic circuit breaker	
F10	Max thermostat	
G1	Heating circ. pump 1	
G2	Heating circ. pump 2	
G5	Circulation pump for hot water heat exchanger	
G11	Charge pump HP1	
G30	Circulation pump, solar panel	
G31	Pump, bore hole recharging	
G32	Pump, plate heat exchanger - solar energy	
G40	Circulation pump for DHW circ.	
G46	Charging pump	
G50	Circulation pump, pool heating	
G61	Circulation pump, active cooling	

Designation	Spec
K1	Contactor 1
K22	Flexible remote control/ SmartGrid
K23	Flexible remote control/ SmartGrid
K24	Flexible remote control/ SmartGrid
K25	Flexible remote control/ SmartGrid
M40	Fan
HP A1	Heat pump A1
X1	Terminal board
X10	Extra terminal board
Y2	Mixing valve 2
Y21	3-way valve DHW 1
Y30	Diverting valve, solar, external buffer tank
Y31	Brine diverting valve, solar
Y41	Mixing valve EHS Tank
Y42	Mixing valve External boiler
Y47	Electric shut-off valve
Y50	3-way valve, pool
Y60	3-way valve, passive cooling
Y61	3-way valve heating / active cooling

*Accessory CTC SmartControl.

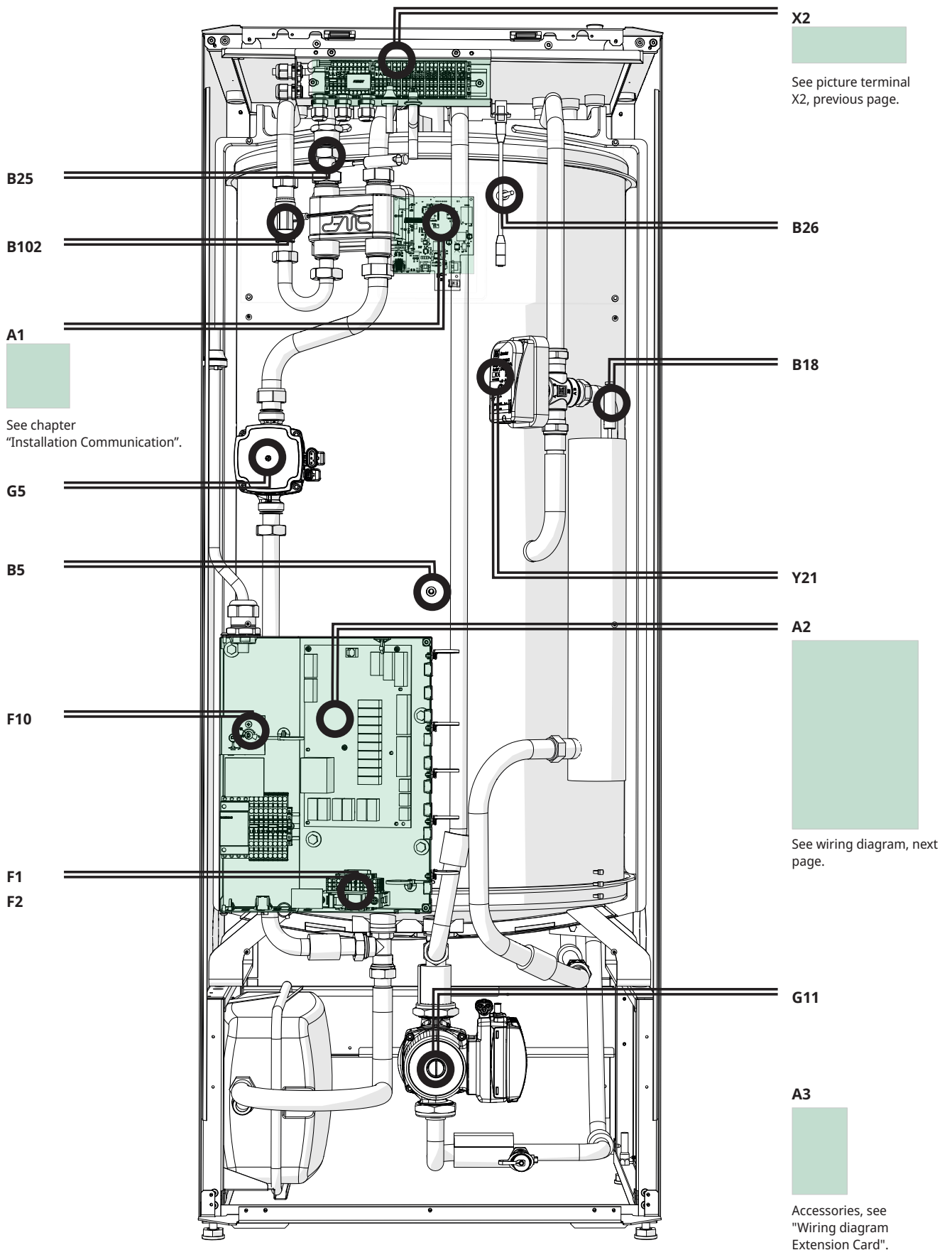

9.4 Wiring diagram CTC EcoZenith i360 3x400V Relay card A2

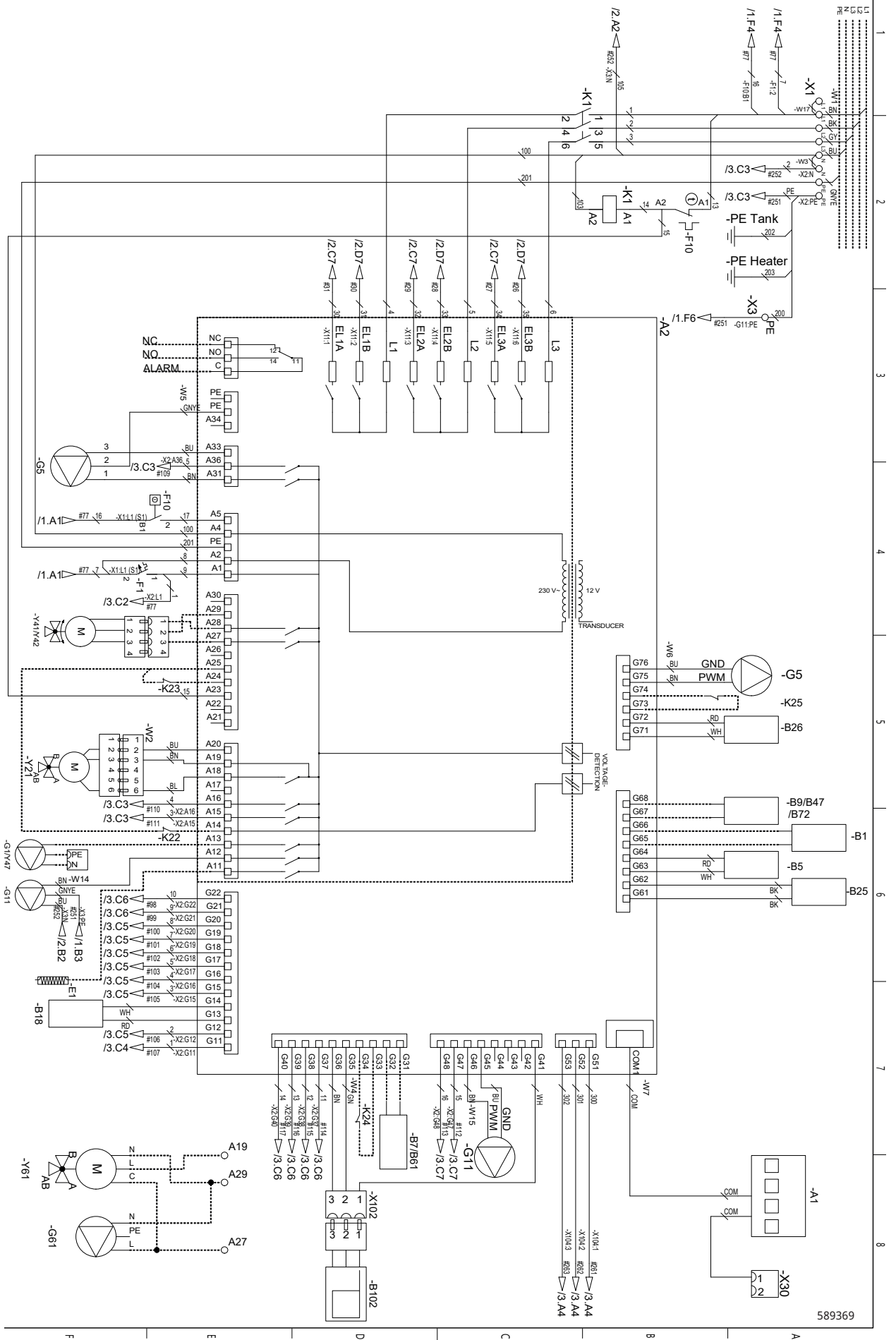

589369

9.5 Wiring diagram CTC EcoZenith i360 3x400V Flow heater E15

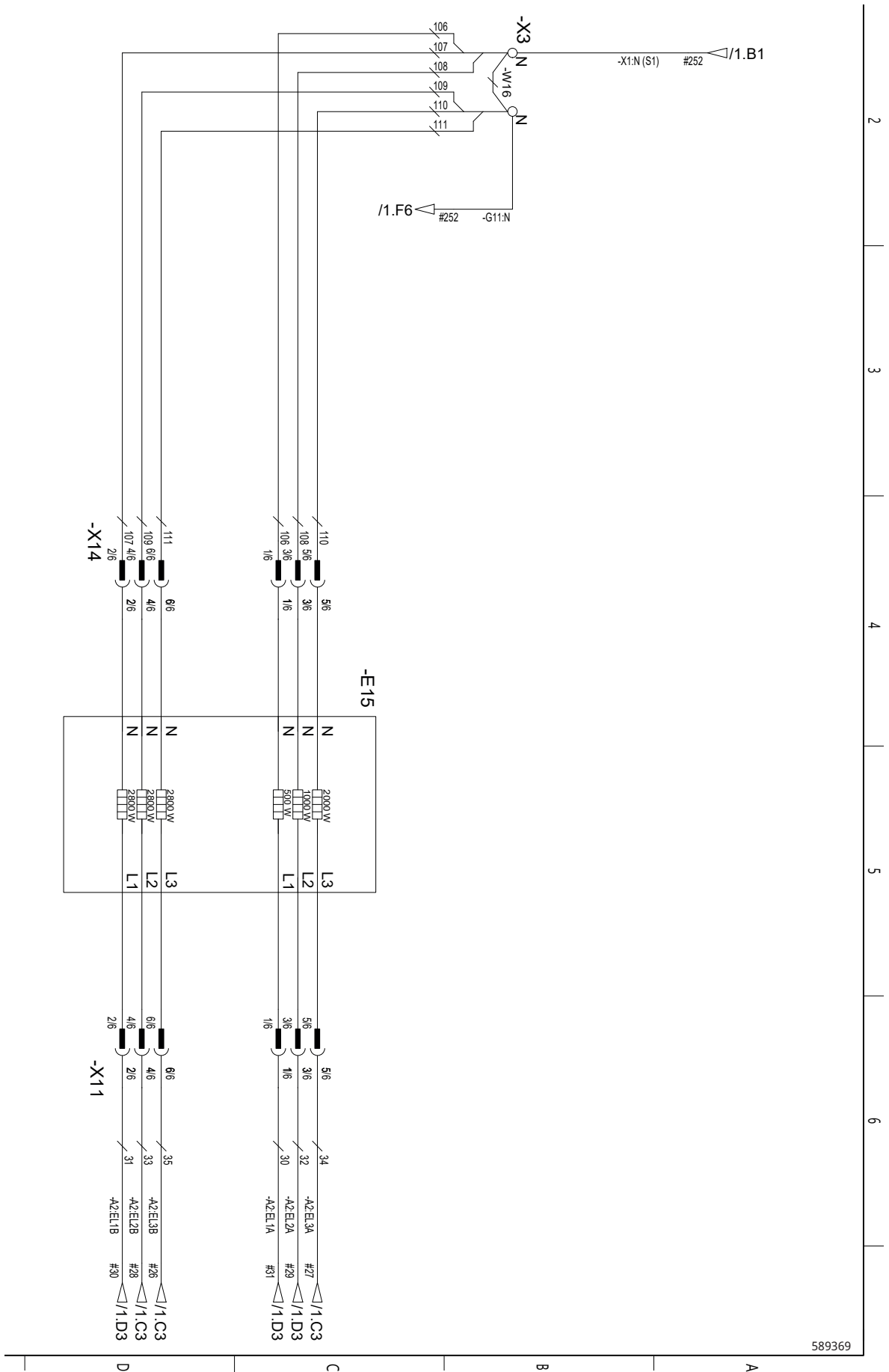

589369

9.7 Wiring diagram CTC EcoZenith i360 1x230V Relay card A2

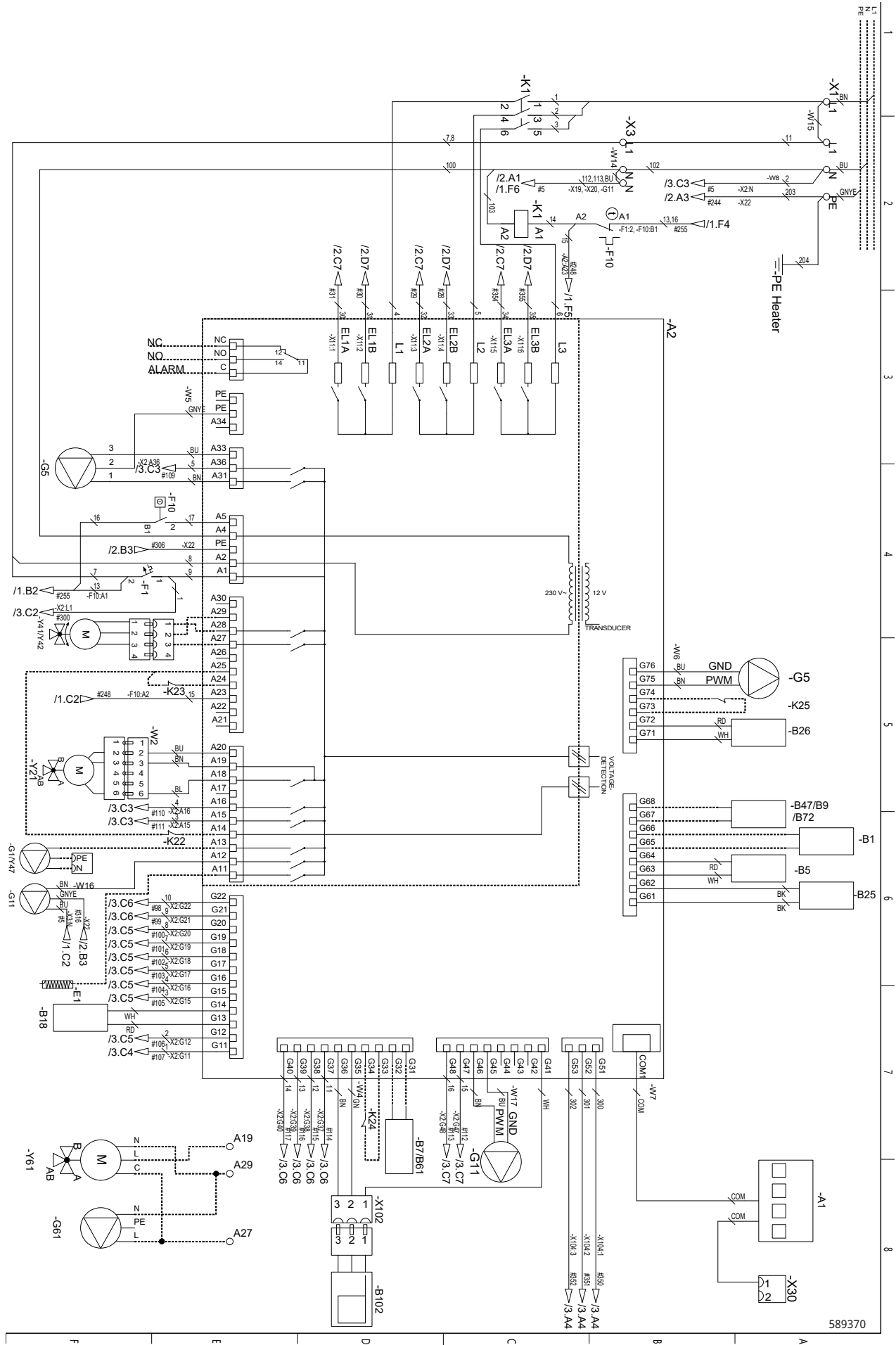

9.8 Wiring diagram CTC EcoZenith i360 1x230V Flow heater E15

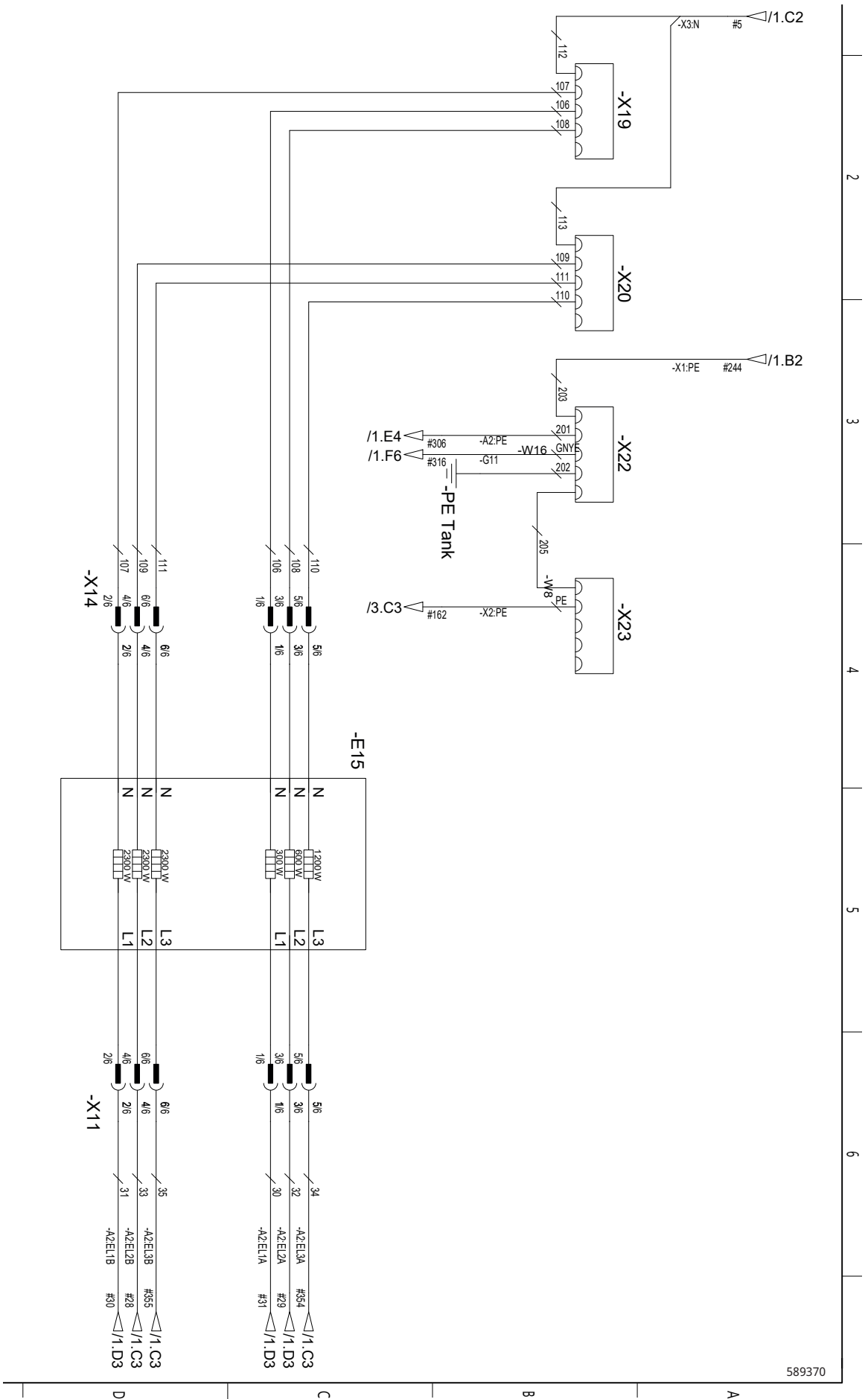

589370

9.9 Wiring diagram CTC EcoZenith i360 1x230V Terminal Block X2

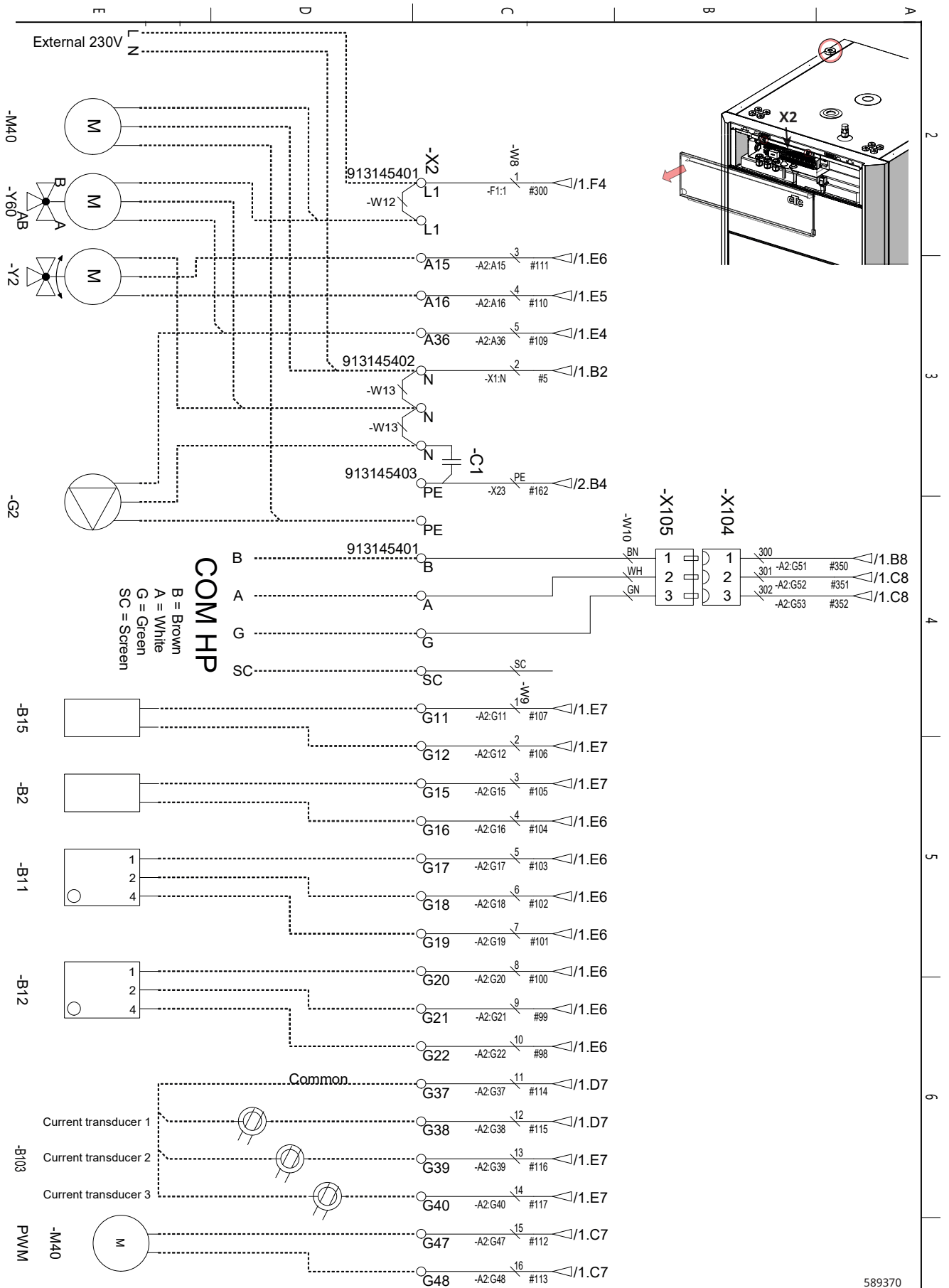

589370

9.10 Wiring diagram CTC EcoZenith i360 3x230V Relay card A2

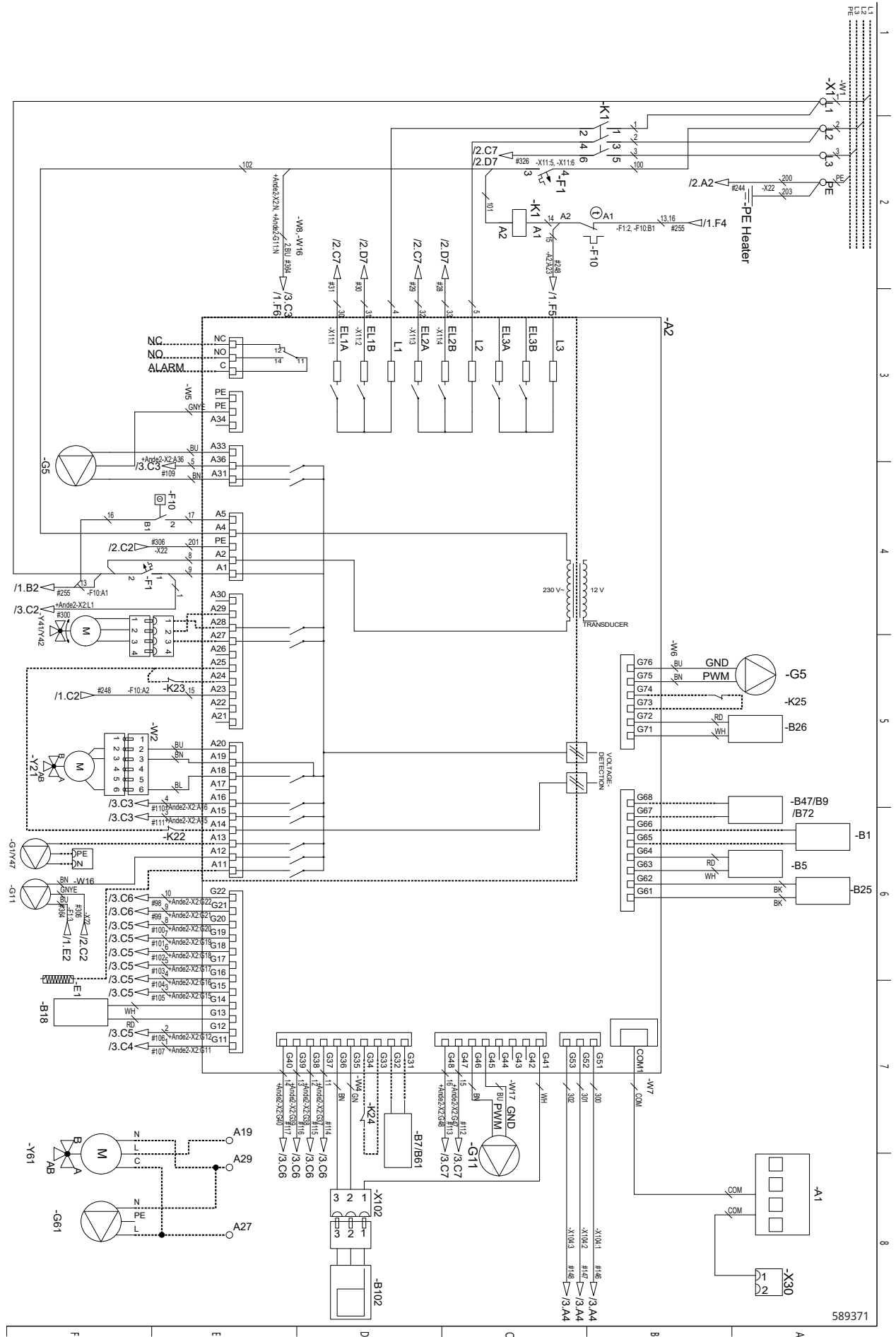

9.11 Wiring diagram CTC EcoZenith i360 3x230V Flow heater E15

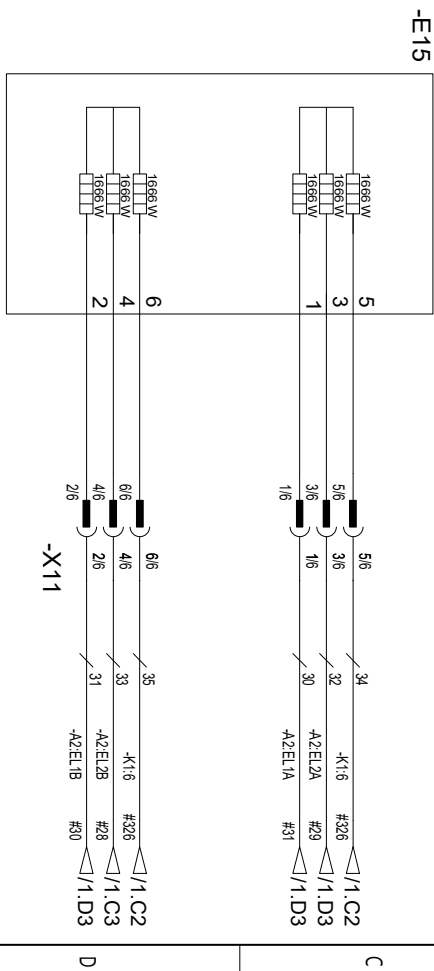
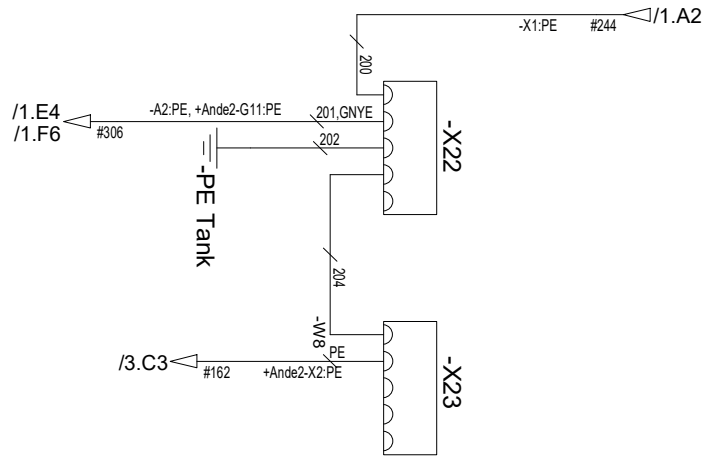

2 3 4 5 6

9.12 Wiring diagram CTC EcoZenith i360 3x230V Terminal Block X2

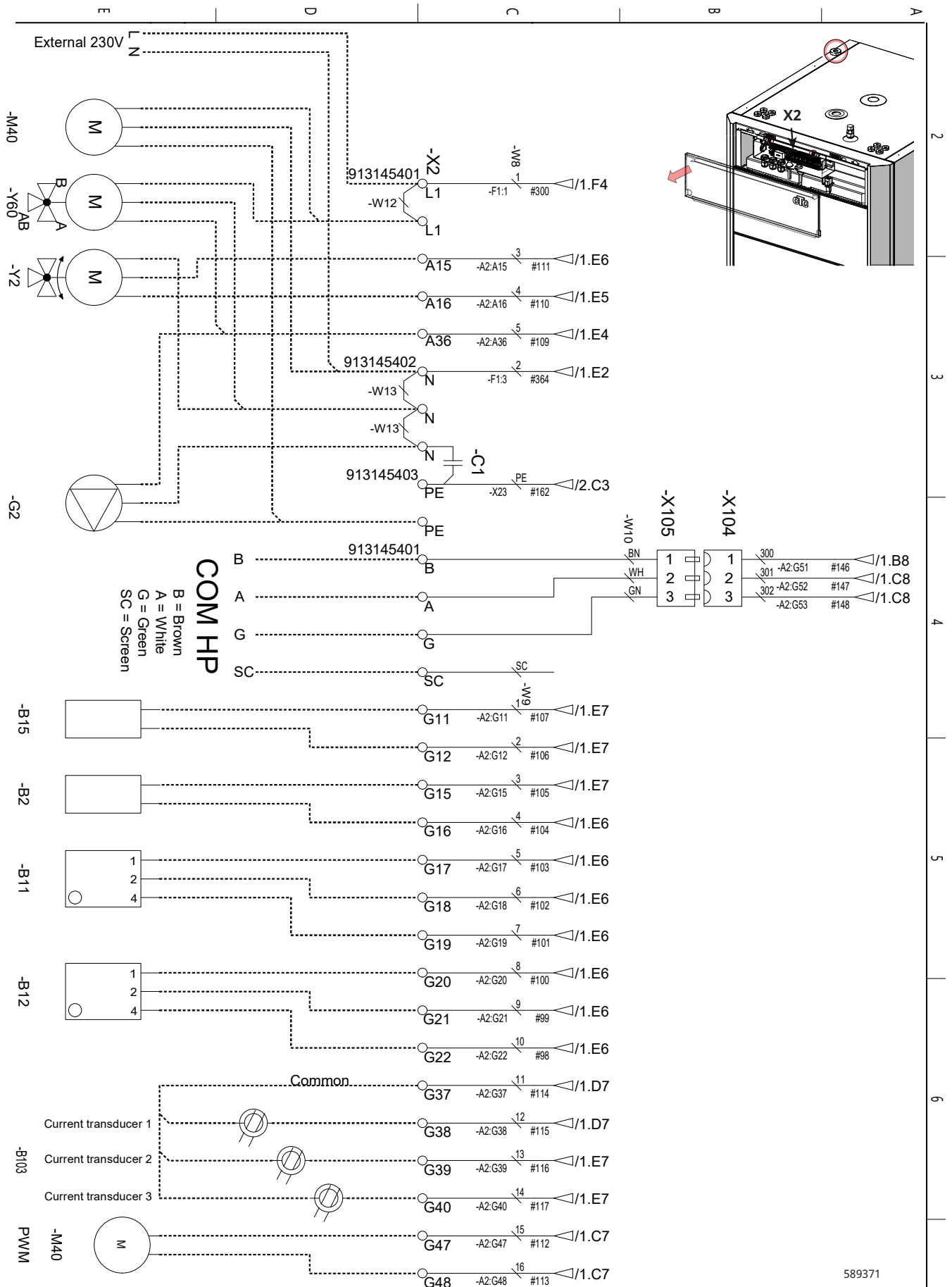

589371

9.13 Connection table for electrical components

This table specifies the connections for components for the EcoZenith i360 relay card A2 or terminal board X2. (See also the wiring diagram).

Connection	Designation	Option	Card	Terminal block	Wire
A1 – Display board	Display		A2	COM A1	Patch
A6	Gateway (accessory CTC SmartControl)		X2		
B1	Primary flow sensor 1	x	A2	G65	*
B1	Primary flow sensor 1	x	A2	G66	*
B2	Primary flow sensor 2	x	X2	G15	*
B2	Primary flow sensor 2	x	X2	G16	*
B5	Sensor, DHW tank		A2	G63	*
B5	Sensor, DHW tank		A2	G64	*
B7	Return sensor	x	A2	G31	*
B7	Return sensor	x	A2	G32	*
B9	External boiler sensor	x	A2	G67	*
B9	External boiler sensor	x	A2	G68	*
B11	Room sensor 1	x	X2	G17	1
B11	Room sensor 1	x	X2	G18	2
B11	Room sensor 1	x	X2	G19	4
B12	Room sensor 2	x	X2	G20	1
B12	Room sensor 2	x	X2	G21	2
B12	Room sensor 2	x	X2	G22	4
B15	Outdoor sensor		X2	G11	*
B15	Outdoor sensor		X2	G12	*
B18	Primary flow sensor		A2	G13	*
B18	Primary flow sensor		A2	G14	*
B25	DHW sensor		A2	G61	*
B25	DHW sensor		A2	G62	*
B26	Sensor, upper hot water tank		A2	G71	*
B26	Sensor, upper hot water tank		A2	G72	*
B47	Sensor EHS-tank	x	A2	G67	*
B47	Sensor EHS-tank	x	A2	G68	*
B61	Sensor, cooling tank	x	A2	G31	*
B61	Sensor, cooling tank	x	A2	G32	*
B72	Return sensor, active cooling	x	A2	G67	*
B72	Return sensor, active cooling	x	A2	G68	*
B102	Flow switch		A2	G35	Green
B102	Flow switch		A2	G36	Brown
B102	Flow switch		A2	G41	White
B103	Current sensor COMMON	x	X2	G37	COMMON
B103	Current sensor L1	x	X2	G38	L1
B103	Current sensor L2	x	X2	G39	L2
B103	Current sensor L3	x	X2	G40	L3

Connection	Designation	Option	Card	Terminal block	Wire
E1	Relay, additional heating		A2	A11	Black/brown
E1	Relay, additional heating		X1	N	Blue
E1	Relay, additional heating		X1	PE	Green/Yellow
External alarm - NC	External alarm		A2	NC	NC
External alarm - No	External alarm		A2	No	No
External alarm - Alarm	External alarm		A2	C	Alarm
G1	Heating circ. pump 1		A2	A13	*
G2	Heating circ. pump 2	x	A2	A36	Brown
G2	Heating circ. pump 2	x	A2	PE	Yellow/Green
G2	Heating circ. pump 2	x	A2	A34	Blue
G5	Circulation pump for hot water heat exchanger		A2	A31	Brown
G5	Circulation pump for hot water heat exchanger		A2	A33	Blue
G5	Circulation pump for hot water heat exchanger		A2	PE	Yellow/Green
G5	Circulation pump for hot water heat exchanger		A2	G75	Brown
G5	Circulation pump for hot water heat exchanger		A2	G76	Blue
G11	Charge pump HP1		A2	A12	Brown
G11	Charge pump HP1		A2	G45	Blue
G11	Charge pump HP1		A2	G46	Brown
G11	Charge pump HP1		X3	N	Blue
G11	Charge pump HP1		X3	Pe	Yellow/Green
G61	Circulation pump, active cooling	x	A2	A27	Black
G61	Circulation pump, active cooling	x	A2	N	Blue
G61	Circulation pump, active cooling	x	A2	PE	Yellow/Green
K22	Flexible remote control/ SmartGrid	x	A2	A14	***
K22/K23	Flexible remote control/ SmartGrid	x	A2	A25	***
K23	Flexible remote control/ SmartGrid	x	A2	A24	***
K24	Flexible remote control/ SmartGrid	x	A2	G33	***
K24	Flexible remote control/ SmartGrid	x	A2	G34	***
K25	Flexible remote control/ SmartGrid	x	A2	G73	***
K25	Flexible remote control/ SmartGrid	x	A2	G74	***
M40	Fan		X2	G47/G48	Blue/Yellow
COM HP – HP A1	Communication heat pump		X2	B	Brown
COM HP – HP A1	Communication heat pump		X2	A	White
COM HP – HP A1	Communication heat pump		X2	G	Green
COM HP – HP A1	Communication heat pump		X2	Sc	Display setup

Connection	Designation	Option	Card	Terminal block	Wire
Y2	Mixing valve 2	x	A2	A15	Black
Y2	Mixing valve 2	x	A2	A16	Brown
Y2	Mixing valve 2	x	A2	A17	Blue
Y21	3-way valve DHW		A2	A18	Black
Y21	3-way valve DHW		A2	A19	Brown
Y21	3-way valve DHW		A2	A20	Blue
Y41	Mixing valve EHS Tank	x	A2	A27	Black
Y41	Mixing valve EHS Tank	x	A2	A28	Brown
Y41	Mixing valve EHS Tank	x	A2	A29	Blue
Y42	Mixing valve External boiler	x	A2	A27	Black
Y42	Mixing valve External boiler	x	A2	A28	Brown
Y42	Mixing valve External boiler	x	A2	A29	Blue
Y47	Electric shut-off valve	x	A2	A13	*
Y60	3-way valve, passive cooling	x	A2	A36	Black
Y60	3-way valve, passive cooling	x	X2	L1	Brown
Y60	3-way valve, passive cooling	x	X2	N	Blue
Y61	3-way valve heating / active cooling	x	A2	A27	Black
Y61	3-way valve heating / active cooling	x	A2	A28	Brown
Y61	3-way valve heating / active cooling	x	A2	A29	Blue

* cable can be connected regardless of terminal block for component

*** Connection according to description of remote control functions.

9.14 Wiring diagram for Expansion card

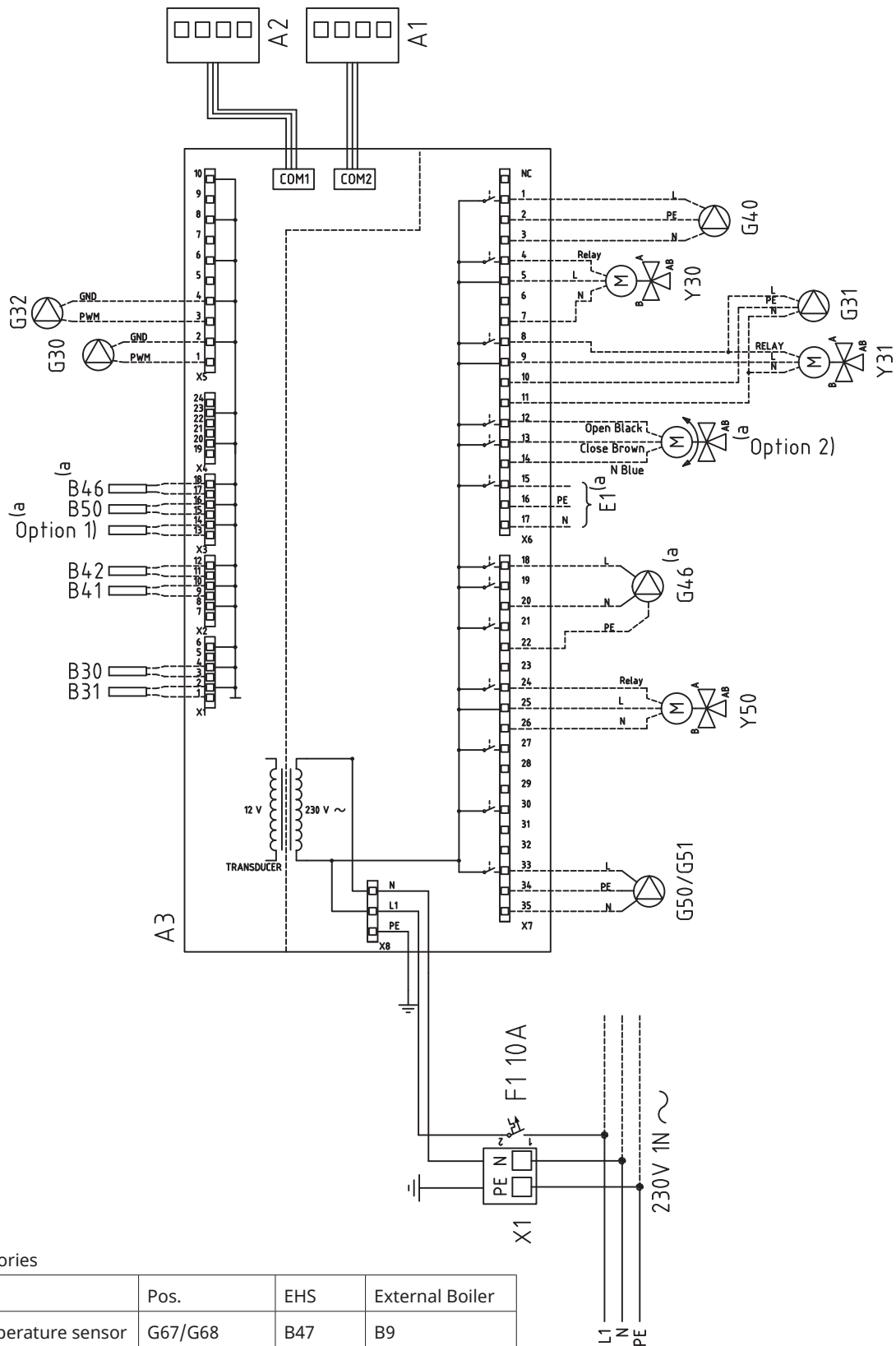

Accessories

No.	Pos.	EHS	External Boiler
1) temperature sensor	G67/G68	B47	B9
2) valve	A27/A28/A29	Y41	Y42

9.15 Connection table for Expansion Card A3

This table shows the connections for components for CTC EcoZenith i360 Extension Card A3. (See also the wiring diagram for the extension card).

	Designation	Terminal block/cable	
A1	Display	COM2	*
A2	Relay/main card	COM1	*
B9	Sensor external boiler	X3:13	*
B9	Sensor external boiler	X3:14	*
B31	Solar panel sensor out	X1:1	*
B31	Solar panel sensor out	X1:2	*
B30	Solar panel sensor in	X1:3	*
B30	Solar panel sensor in	X1:4	*
B41	Sensor, external buffer tank upper	X2:9	*
B41	Sensor, external buffer tank upper	X2:10	*
B42	Sensor, external buffer tank lower	X2:11	*
B42	Sensor, external buffer tank lower	X2:12	*
B46	Sensor, diff. thermostat	X3:18	*
B46	Sensor, diff. thermostat	X3:19	*
B47	Sensor, EHS-tank	X3:13	*
B47	Sensor, EHS-tank	X3:14	*
B50	Sensor pool	X3:15	*
B50	Sensor pool	X3:16	*
G30	Circulation pump, solar panel	X5:1	PWM
G30	Circulation pump, solar panel	X5:2	GND
G32	Pump, plate heat exchanger – solar energy	X5:3	PWM
G32	Pump, plate heat exchanger – solar energy	X5:4	GND
G40	Circulation pump for DHW circ.	X6:1	L
G40	Circulation pump for DHW circ.	X6:2	PE
G40	Circulation pump for DHW circ.	X6:3	N
G31	Pump, bore hole recharging	X6:8	L
G31	Pump, bore hole recharging	X6:10	PE
G31	Pump, bore hole recharging	X6:11	N
E1	Relay, external boiler	X6:15	L
E1	Relay, external boiler	X6:16	PE
E1	Relay, external boiler	X6:17	N

	Designation	Terminal block/cable	
G46	Charging pump	X7:18	L
G46	Charging pump	X7:20	N
G46	Charging pump	X7:22	PE
G50	Circulation pump, pool heating	X7:33	L
G50	Circulation pump, pool heating	X7:34	PE
G50	Circulation pump, pool heating	X7:35	N
G51	Circulation pump, pool heating	X7:33	L
G51	Circulation pump, pool heating	X7:34	PE
G51	Circulation pump, pool heating	X7:35	N
Y30	Diverting valve, solar, external buffer tank	X6:4	Relay
Y30	Diverting valve, solar, external buffer tank	X6:5	L
Y30	Diverting valve, solar, external buffer tank	X6:7	N
Y31	Brine diverting valve, solar	X6:8	Relay
Y31	Brine diverting valve, solar	X6:9	L
Y31	Brine diverting valve, solar	X6:11	N
Y50	3-way valve, pool	X7:24	Relay
Y50	3-way valve, pool	X7:25	L
Y50	3-way valve, pool	X7:26	N

* cable can be connected regardless of terminal block for component.

9.16 Sensor connection

The sensor is connected on top of terminal X2, behind the magnetic strip.

See the wiring diagram and connection table for correct connection.

Sensor terminal block

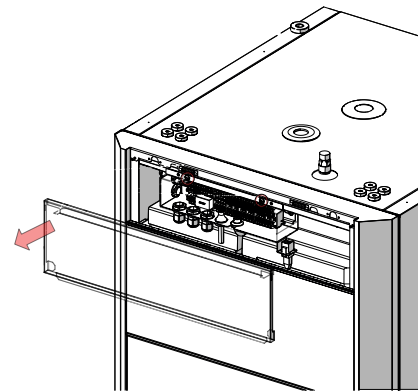
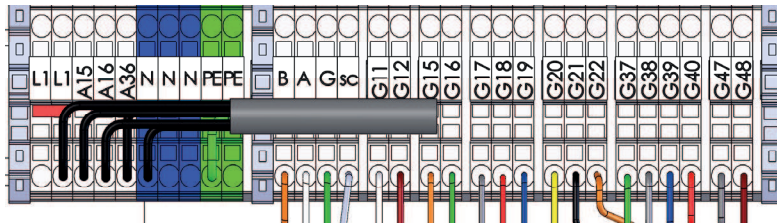

9.16.1 Connection of outdoor sensor (B15)

The sensor should be set up on the house's northwest or north side, so that it is not exposed to morning and evening sun. If there is a risk of the sensor being affected by the sun's rays, it must be protected by a screen.

Place the sensor at around 2/3 of the height of the facade near a corner, but not under a roof projection or other form of wind protection. Do not place it either above ventilation ducts, doors or windows where the sensor may be affected by factors other than the actual outdoor temperature.

Do not attach the sensor cable permanently until you have tested where the best location is.

9.16.2 Connection of room sensors (B11 and B12)

The room sensor is fitted at a central point in the house, in the most open position possible, ideally in a hall between several rooms. This is the best position for the sensor to record an average temperature for the house.

Feed a three-core cable (minimum 0.5 mm²) between the product and the room sensor. Then attach the room sensor securely in a position roughly two thirds of the way up the wall. Connect the cable to the room sensor and the product.

When connecting a wireless room sensor (accessory), refer to the "Wireless room sensor" manual.

Check room sensor connection

- Go to the menu: "Installer/Service/Function test/Heating circuit".
- Go down and select the option LED room sensor and press OK.
- Select "On" using the "+" button and press "OK". Check that the room sensor LED lights up. If not, check the cables and connection.
- Select "Off" using the "-" button and press "OK". If the OK LED goes off, the check is complete.
- Return to the start menu by pressing the "Home" button.

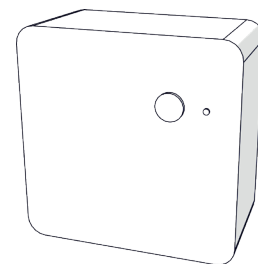
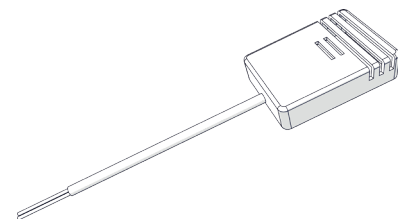

9.16.3 Installation of sensor on pipe

The sensing part is towards the end of the sensor (see sketch).

- Attach the sensor using the cable tie provided.
- Ensure that the sensor makes good contact with the pipe. Apply contact paste to the front part of the sensor between the sensor and the pipe if good contact is otherwise difficult to obtain.
- **Important!** Insulate the sensor using pipe insulation.
- Connect the cables to the sensor terminal block.

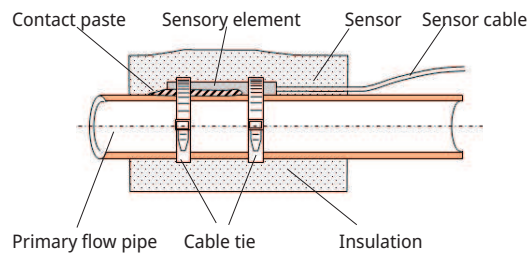

9.16.4 Primary flow sensor connection (B1 & B2)

When connecting primary flow sensors 1 (B1) and 2 (B2), fit the primary flow sensor to the primary flow pipe, ideally after the circulation pump.

- Free cooling is adjusted using primary flow sensor 2 (B2), which then means that heating circuit 2 and cooling cannot be used simultaneously.

9.16.5 Return sensor connection for installation without a heat pump

When connecting the return sensor (B7), fit the product to the return pipe before connecting to the product.

9.16.6 Checking connected sensors

If any sensor is incorrectly connected, a message will appear on the display, e.g. "Alarm sensor outside". If several sensors are incorrectly connected, the different alarms are displayed on different rows.

If no alarm is displayed, the sensors are correct.

9.17 Current sensor connection

A current sensor with three sensors is used for product models with 400V 3N~50Hz (3x400V) and 230V 3N~ 50Hz (3x230V) connections (see technical data).

The three current sensors, one for each phase, are fitted on the fuse panel. Each phase from the electricity distribution board supplying the product is channelled through a current sensor before termination at the relevant terminal. This allows the phase current to be sensed all the time and compared with the value set for the product's load switch. If the current is higher, the control unit drops to a lower heat output on the immersion heater. If this is insufficient, the installed heat pump is also limited. When the power drops back below the set value, the heat pump and immersion heater are reconnected. This means that the current sensors, along with the electronics, prevent more power being supplied than the main fuses can tolerate.

A main fuse of up to 35 A is permitted. If the main fuse is larger, a conversion rate must be used.

The current sensors' cable holes are 11 mm in diameter.

The current sensor connection has no alarm, but the current value can be read in the Operation data menu. Note that the tolerance/accuracy is very low with small current values.

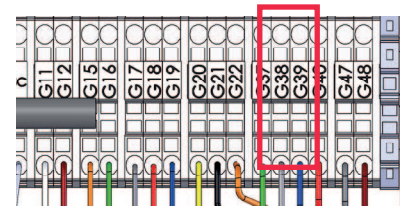

Connect to sensor terminal block (see wiring diagram). Use at least a 0.5 mm² cable.

9.18 Setting electrical output in backup power supply

The DIP switch on the relay card (A2) is used to set the backup power supply. The DIP switch is marked "RESERV" (BACKUP).

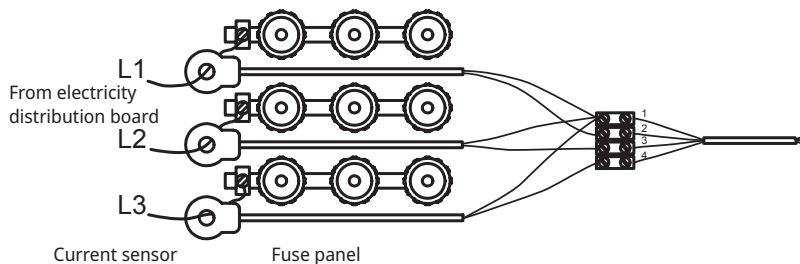

When the switch is set to ON, the step is actively operating in backup heating mode. The factory-set mode is as shown in the image on the right.

	Power from each step for immersion heater [kW]					
	EL1A	EL1B	EL2A	EL2B	EL3A	EL3B
EcoZenith i360 3x400V	0.5	2.8	1	2.8	2	2.8
EcoZenith i360 1x230V	0.3	2.3	0.6	2.3	1.2	2.3
EcoZenith i360 3x230V	3	3	3	3	-	-

To give the total power for backup heating for 3X400 and 1x230, the power on the active relays is added together; for 3x230V the total power varies depending on the combination (see connection on wiring diagram). The power may need to be adjusted to the building.

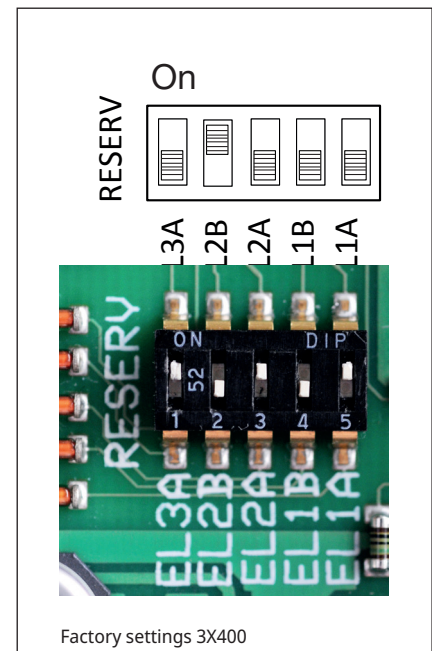

Factory settings 3X400

9.19 Resistance table for sensor

[°C]	NTC 22K [Ω]	NTC 150 [Ω]	NTC 015 WF00 [Ω]
130	800		
125	906		
120	1027		
115	1167		
110	1330		
105	1522		
100	1746		
95	2010		
90	2320		
85	2690		
80	3130		
75	3650		
70	4280	32	
65	5045	37	
60	5960	43	
55	7080	51	
50	8450	60	
45	10130	72	
40	12200	85	5830
35	14770	102	6940
30	18000	123	8310
25	22000	150	10000
20	27100	182	12090
15	33540	224	14690
10	41800	276	17960
5	52400	342	22050
0	66200	428	27280
-5	84750	538	33900
-10	108000	681	42470
-15	139000	868	53410
-20	181000	1115	67770
-25	238000	1443	86430
-30		1883	
-35		2478	
-40		3289	

10. Installation Communication

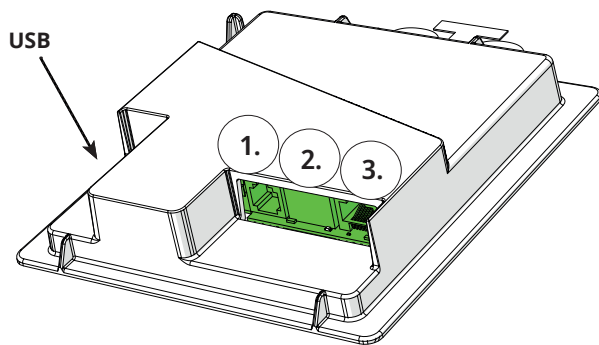

The back of the display unit has 3 communication ports.



Menu: "Installer/Define/Communication".



Display communication ports

- 1 **Port 1. RS485 port without galvanic protection. For external equipment, e.g. property control (BMS*).**

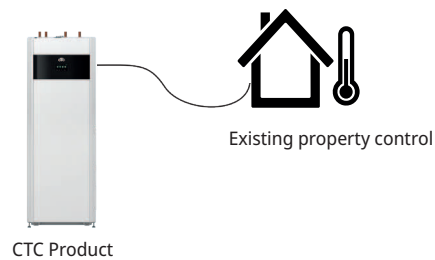

- 2 **Port 2. Network jack (ethernet), see connection information on following page.**
Define the app:
myUplink: "Yes" enables connection to the app.

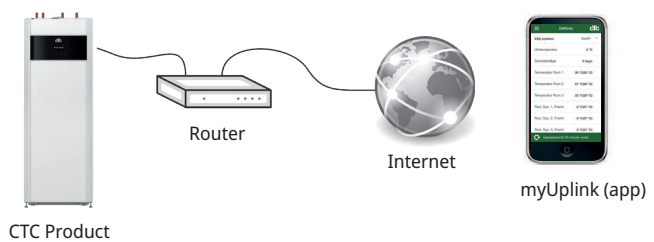

Define Web:
"Yes" permits network connection, the "CTC Remote" screen mirror feature and BMS* function with remote control via network cable to local network.

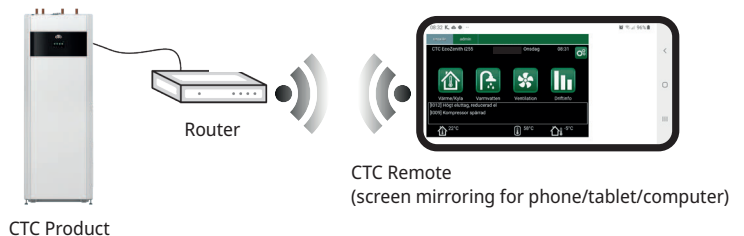

- 3 **Port 3. Communication between the product's electrical cabling and display: Factory fitted.**

*Port 2 - Network socket (Ethernet) when connecting the BMS via TCP/IP.

10.1 Install ethernet cable

In order to define and enable connection to the network and app, an ethernet cable must be connected as described below.

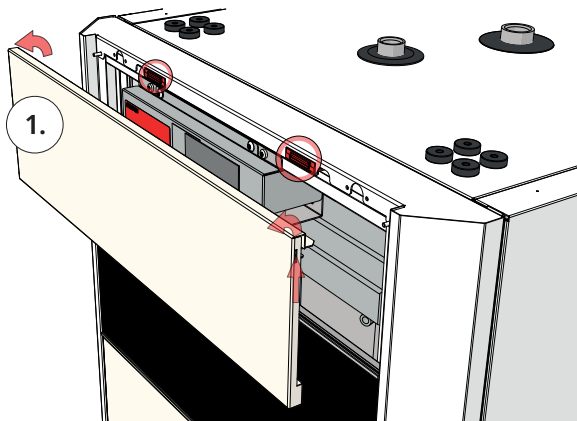

1. Pull out the magnetic strip. It is secured with magnets. If difficult to remove, use a small screwdriver in the notch along the top edge.

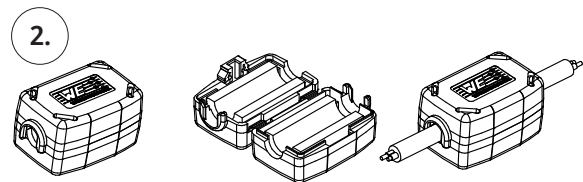

2. Open the ferrite from the packaging, clamp around the ethernet cable with the connector.

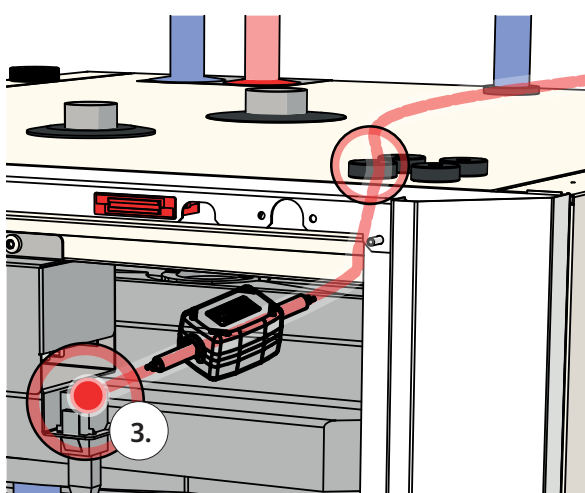

3. Connect the ethernet cable.

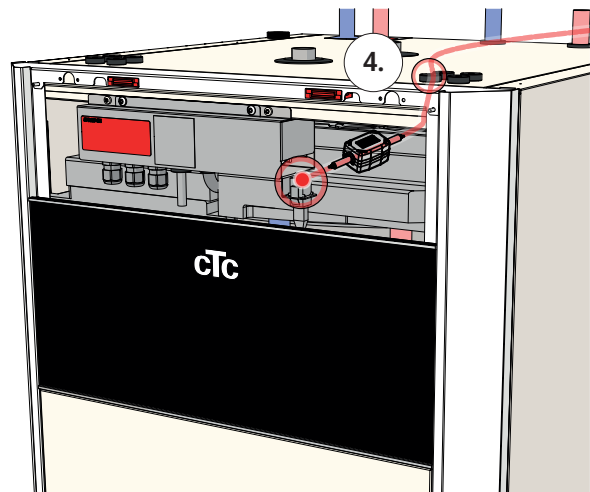

4. Route the ethernet cable through any hole in the top cover, remove rubber grommet if necessary.

5. Connect ethernet cable to network port or router.

To permit and define connectivity, refer to the "Communication" section in the "Installer/Define" chapter.



10.2 Remote - Screen Mirroring

- Connect the ethernet cable, see previous page.
- Installer/Define/Communication/Web – Yes. Permits the product to connect with unencrypted web traffic on local area networks. Internet router and firewall required.
- Installer/i – Scan the QR code with a tablet or smartphone. 
- Save as favourite/icon on phone/tablet/computer. When your phone/tablet is connected to your local network, the product can be used with your device's touchscreen in the same way as the product's screen.
- In the app: scan QR code or enter address "http://ctcXXXX/main.htm". (XXXX = the last four digits of the display serial number, for example S/N 888800000040 = "http://ctc0040/main.htm"). In case of problems: click the link to update to the device's current IP no.

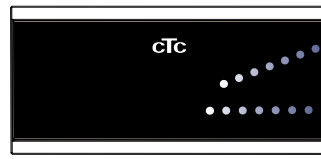

Tablet/Smartphone/PC as a touchscreen for local area network "Installer/Define/Communication/Web" – "Yes".

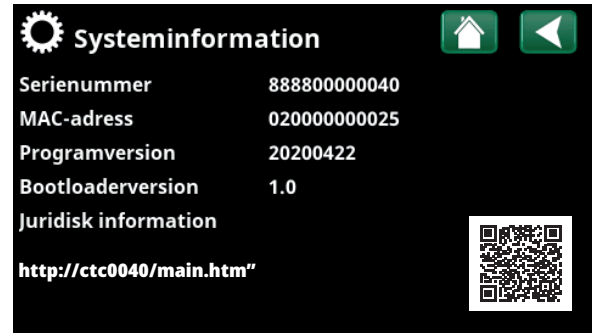

10.3 myUplink - App

Define myUplink. See "Installer/Define/Communication/myUplink – Yes".

Installing the app.

- Download myUplink from the AppStore or Google Play.
- Create an account.
- Follow the instructions in the app's Help feature.

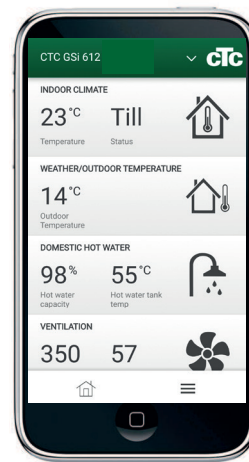

11. First start

CTC EcoZenith i360 can be installed and started before the ground source or air-to-water heat pump is put into operation. In order to use the product as electric boiler before a heat pump is installed, the installation engineer must connect the pipes to and from the heat pump (see the pipe installation section). The product can also be started without a room sensor being fitted as the curve which has been set then regulates the heating. The sensor can, however, always be fitted for the alarm LED function.

Before first start

1. Check that the product and system are full of water and have been bled. (CTC EcoZenith i360 is bled manually with a safety valve on the top cover of the product, activate the automatic bleeder as well for the first three months).
2. For installation with a heat pump, follow the instructions in the heat pump manual.
3. Check that all connections are tight.
4. Check that the sensor and radiator pump are connected to the power source. Check that the connections behind the insulation cap remains tight. Remove both insulation caps by pulling carefully on the points marked.
5. The backup heating thermostat is factory-set to OFF (off position when it is turned anticlockwise as far as it will go, at which point the screwdriver slot is vertical). Recommended mode is $\star\star$ = Frost protection setting, approx. +7 °C. The backup heating thermostat is in the electrical switchboard behind the front panel. See the image on the right for what the antifreeze setting looks like.

At the end of the installation, check the connections of any current sensors. At this point it is important that you have switched off any major electricity-consuming appliances in the house. Also make sure that the backup heating thermostat is turned off.

NB: The product has an automatic bleeding sequence for the DHW system, which runs in the background. The sequence takes approx. 15 minutes and does not affect other functions.

First start-up

Connect the power with the safety switch, the display window lights up. For settings, see chapter "Installation Guide".

When only an electric boiler is operating

When starting the product without a borehole, it is necessary to specify the electrical power for hot water production in the menu "Advanced/Settings/ Immersion heater/Max immersion heater DHW kW".

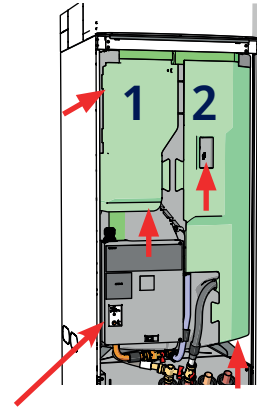

Check connections.

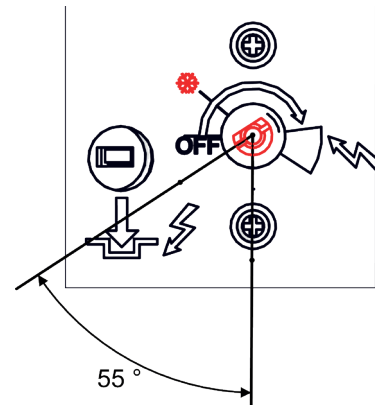

Position for frost protection setting.

i The selected power output must be written on the rating plate with a marker.

i Save these settings under: Installer/Settings/Save settings.

11.1 Installation wizard

When starting up the system and during reinstallation (refer to the "Installer /Service" chapter), a number of system options must be selected. The dialogue boxes which will then be displayed are described below. The values shown in the menu screenshots below are only examples.

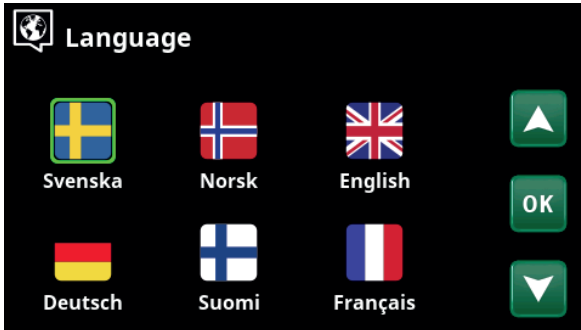

1. Choose language. Press OK to confirm.



2. Select the country where the heat pump is installed. Press OK to confirm.

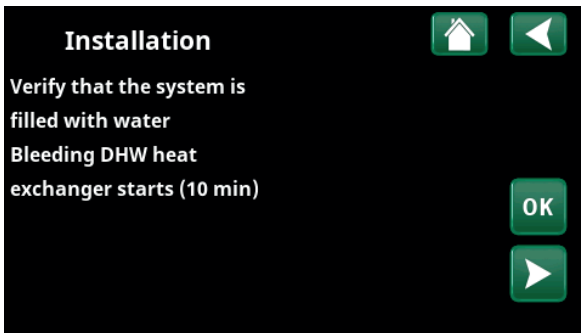

3. Verify that the system is filled with water. Confirm with "OK" and the "right" directional arrow.

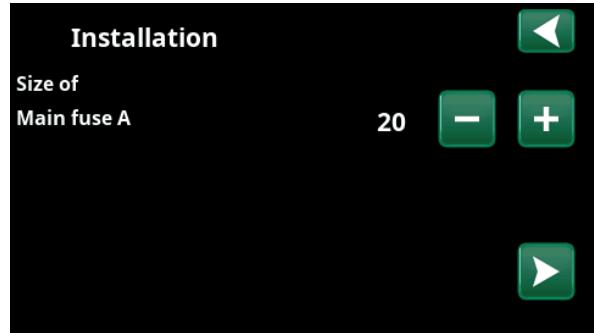

4. Select the size of the main fuse using the "+" and "-" buttons. Confirm with the "right" directional arrow. For more information about settings, refer to the "Installer/Settings/Electric Heater" chapter.

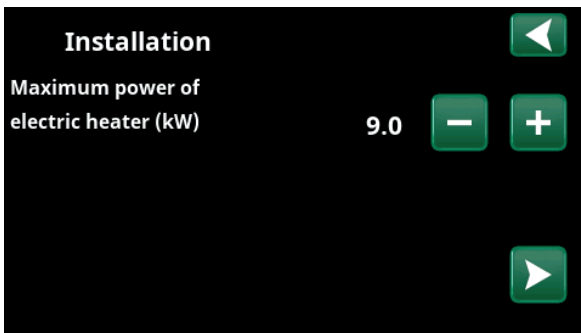

5. Select maximum electric heater power using the "+" and "-" buttons. Confirm with the "right" directional arrow. For more information about settings, refer to the "Installer/Settings/Electric Heater" chapter.

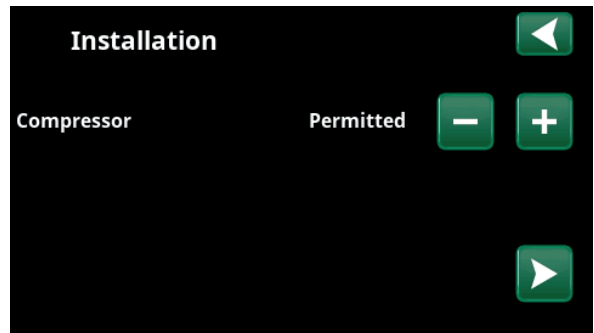

6. Specify whether the compressor is "Permitted" or "Blocked" using the "+" and "-" buttons. Confirm with the "right" directional arrow.

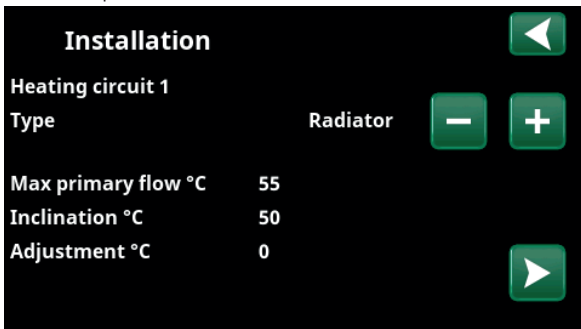

7. Specify whether heating circuit 1 applies to radiators or underfloor heating. Switch between "Radiator" and "Underfloor Heating" using the "+" and "-" buttons. Confirm with the "right" directional arrow.

8. If Heating circuit 2 is defined, the corresponding menu for this system is displayed. Make a corresponding selection ("Radiator" and "Underfloor Heating") for Heating circuit 2 and finish the wizard with "OK".

i When operating as an electric boiler only, the settings must be changed:

"Installer/Settings/DHW":

- "Add. Heat DHW": Yes.
- "DHW" Select mode: "Comfort".

Enter the set values in the parameter list so that the customer knows what has been set in addition to factory settings during installation.

12. Operation and Maintenance

The installation engineer together with the property owner must check that the system is in perfect operating condition. The installation engineer must show the switches, controls and fuses to the property owner so that the owner knows how the system works and how to service it. Bleed the radiators after approximately three days of operation. Fill with water as needed via the filling valve if the manometer shows that the system pressure is too low.

Operation stop

The product is turned off using the omnipolar switch. If there is a risk of the water freezing, all the water should be drained from the heat pump and the heating circuit.

Draining the tank

The product should be disconnected from the power source while it is being drained. The draining valve for the low model is situated in the bottom right as viewed from the front, behind the product's front panel. For the high model, the drainage valve is included in the additional pack and the pipe installation engineer chooses where to connect the valve. Air must be supplied to the closed system.

Boiler and heating circuit bleeding/safety valve

Check around four times a year that the valve is working correctly by manually turning the control. Check that there is water and not air coming out of the waste pipe; if air is coming out then the tank will need to be bled. Open the screw on the automatic bleeder for the first few months; the screw should then be closed to avoid damaging the bleed valve.

Cleaning the dirt filter and solenoid filter ball valve

Regularly clean the dirt filter (close off incoming tap water, remove and clean the filter) and solenoid filter ball valve (close off the flow to the heat pump, remove and clean the filter).

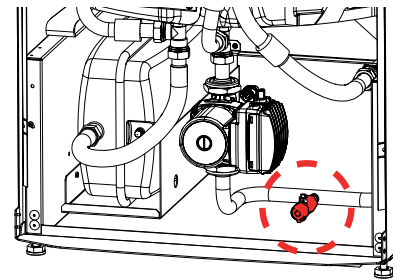

Drainage valve

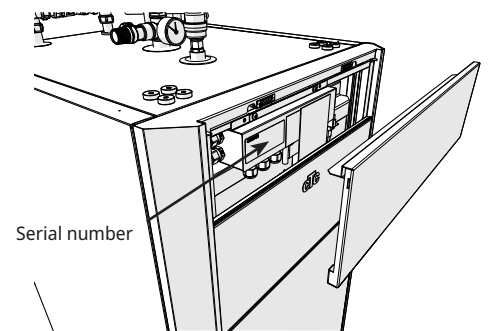

Serial number

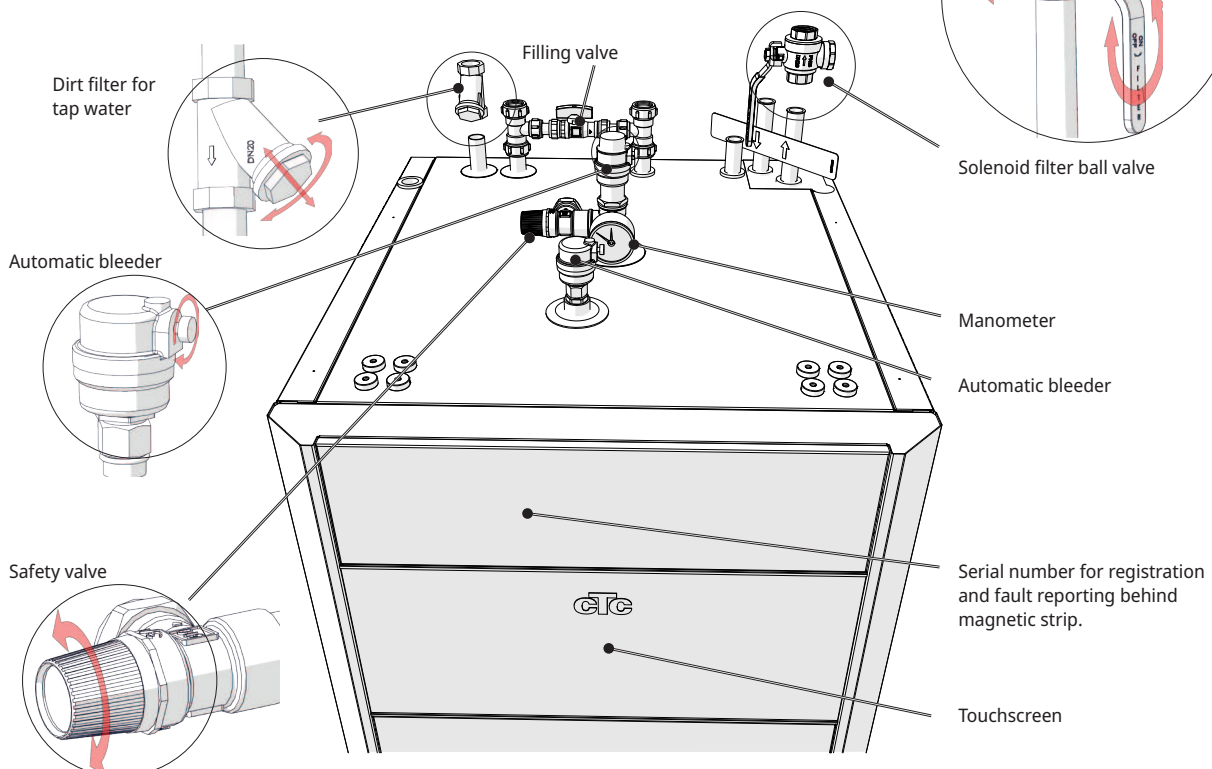

13. System adjustments

13.1 Adjust circulation pump

The charge pump/circulation pump speed for the radiator system is set depending on the system type. Make sure the flow through the heat pump is enough.

The circulation pump is factory-set to 90%, and adjustable to [25–100%]. This can be changed in the display under “Installer/Settings/Heating circuit/Charge pump %”.

- If the products do not work effectively, or if the heat in the radiator system is uneven because the flow is too low, the capacity of the charge pump can be increased. If the flow is too low, the heat in the radiators and floor heating circuits will become uneven. This requires a higher primary flow temperature to compensate, which will make heat pump operation more expensive.
- If there is noise in the radiator system caused by the flow being too high, the capacity of the charge pump can be reduced. As well as noise, unnecessarily high flow means more energy consumption/cost.

For CTC EcoZenith i360, the radiator system’s flow must go through the heat pump; the pump needs to be set to produce the minimum flow for the heat pump and the building.

Step 1 Calculate required flow

Read the flow required by the heating circuit from the table below. The following approximations can be used as a simple rule of thumb: 40–45 W/m² for a newer house and 50–60 W/m² for an older house.

Required power [kW]	New house [m ²] 42.5 W/m ²	Older house [m ²] 55 W/m ²	delta 5 degrees e.g. underfloor heating circuit 40/35 [l/s]	delta 10 degrees e.g. heating circuit 55/45 [l/s]
4	94	73	0.19	0.10
5	118	91	0.24	0.12
6	141	109	0.29	0.14
7	165	128	0.33	0.17
8	188	145	0.38	0.19
9	218	164	0.43	0.22
10	235	182	0.48 – CTC Volume tank required	0.24
11	259	200	0.53 – CTC Volume tank required	0.26
12	282	218	0.57 – CTC Volume tank required	0.29
13	306	236	0.62 – CTC Volume tank required	0.31
14	329	255	0.67 – CTC Volume tank required	0.33
15	353	273	0.72 – CTC Volume tank required	0.36
16	376	291	0.77 – CTC Volume tank required	0.38
17	400	309	0.81 – CTC Volume tank required	0.41
18	424	327	0.86 – CTC Volume tank required	0.43
19	447	345	0.91 – CTC Volume tank required	0.45
20	471	364	0.96 – CTC Volume tank required	0.48 – CTC Volume tank required

Power requirement for this building: _____ [kW]

This building requires: _____ [l/s]

Available pressure remaining according to pressure differential diagram in chapter 9.4 _____ [kPa]

Step 2 Check minimum heat pump flow

To install an air-to-water heat pump, the flows shown below must be used even if step 1 gives a lower flow.

CTC EcoAir 406	0,21 l/s	CTC CombiAir 6M	0,19 l/s
CTC EcoAir 408	0,27 l/s	CTC CombiAir 8M	0,19 l/s
CTC EcoAir 510,610, 614	0,21 l/s	CTC CombiAir 12M	0,29 l/s
CTC EcoAir 622	0,39 l/s	CTC CombiAir 16M	0,39 l/s

This building requires: _____ [l/s]

Step 3 Check whether a volume tank is needed

If the flow is below 0.45 l/s, the system can manage without a CTC Volume tank. If the system has a high pressure differential, a volume tank may be required. If the required flow is greater than 0.45 l/s, this accessory should be installed.

A CTC Volume tank must be installed to increase the flow in the system in the following cases:

- If the flow exceeds 0.45 l/s.
- If a mixing valve for an EHS-tank or external peak needs to be installed and the flow exceeds approx.: 0.35 l/s.
- If the flow in the heating circuit can be closed quickly, e.g. floor heating with no bypass etc.

A CTC Volume tank should be installed in the following cases:

- The system volume is less than 20 litres per kW heat pump to achieve good operation.

Step 4 Dimension the pipeline to the heat pump

The pipe dimensioning between the heat pump and CTC EcoZenith i360 depending on flow and number of metres between the products (single route).

flow [l/s]	copper pipe 22 mm [m]	copper pipe 28 mm [m]	copper pipe 35 mm [m]
0.1	>20	>20	>20
0.12	>20	>20	>20
0.14	>20	>20	>20
0.17	21	>20	>20
0.19	17	>20	>20
0.22	12	>20	>20
0.24	10	>20	>20
0.26	8	>20	>20
0.29		>20	>20
0.31		18	>20
0.33		15	>20
0.36		12	>20
0.38		10	>20
0.41		8	>20
0.43			18
0.45			15

If a CTC Volume tank is installed to increase flow, the flow between the heat pump and CTC Volume tank is calculated according to the flow below.

CTC EcoAir 406	0,21 l/s	CTC CombiAir 6M	0,19 l/s
CTC EcoAir 408	0,27 l/s	CTC CombiAir 8M	0,19 l/s
CTC EcoAir 510, 610, 614	0,21 l/s	CTC CombiAir 12M	0,29 l/s
CTC EcoAir 622	0,39 l/s	CTC CombiAir 16M	0,39 l/s
CTC EcoPart 406	0,14 l/s		
CTC EcoPart 408	0,20 l/s		
CTC EcoPart 410	0,24 l/s		
CTC EcoPart 412	0,28 l/s		
CTC EcoPart 612M	0,29 l/s		
CTC EcoPart 616M	0,52 l/s		

This building requires: _____ l/s between heat pump and CTC Volume tank.

This building requires: _____ l/s to the heating circuit.

Example: House with 11 kW floor heating where an EcoAir 610 is to be installed.

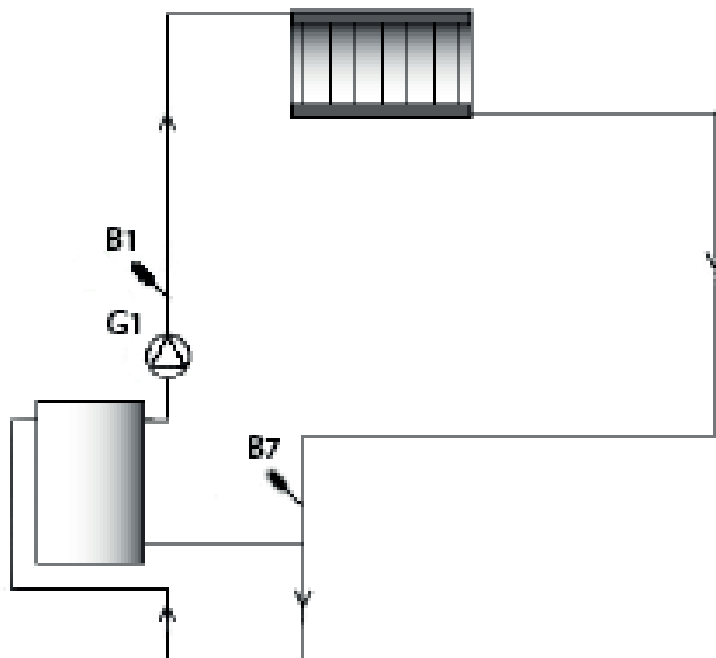

The heating circuit requires a flow of 0.53 l/s. External circulation pump G1 is designed for this flow. The heat pump requires a flow of 0.21 l/s.

Step 5 Set % of PWM signal on the charge pump

Use the pump and pressure differential diagram overleaf to determine the speed [%] according to which the circulation pump/charge pump should be set.

13.2 Pump curve for heating medium system circulation pump

25/125-130 PWM, 1x230V, 50/60Hz

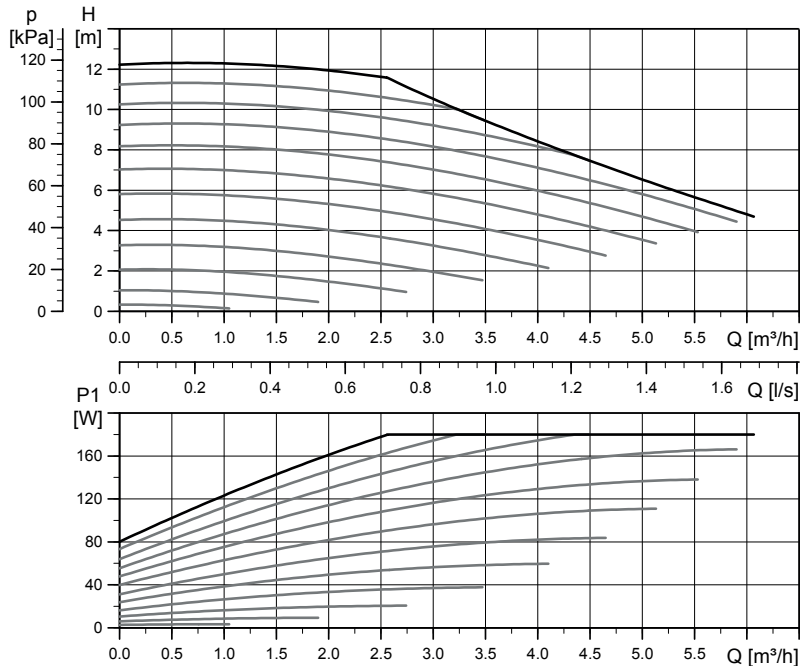

El. data, 1x230V, 50Hz

Speed	P ₁ [W]	I _{1/1} [A]
Min.	3	0.06
Max.	180	1.4

The circulation pumps in CTC's products have energy efficiency class A.

13.3 Flow check

Once the system has been in operation and stabilised and as the outdoor temperature gets colder, the temperature differential between HPout and HPin should be checked so that the set flow speed is enough:

For heat pump in product range:

- EcoAir 400, see table in installation instructions for heat pump.
- EcoAir/EcoPart 600M series:
Underfloor heating: HPout-HPin should not exceed 5 degrees, when RPS > 20.
radiators: HPout-HPin should not exceed 10 degrees, when RPS > 20.
If HPout-HPin is greater, the circulation pump speed should be increased.
With an outdoor temperature of -15°C, the temperature differential should be around 5/10 degrees depending on the temperature differential the system is designed for.
- EcoPart 400, see table in installation instructions for heat pump.

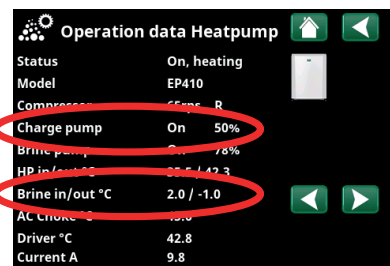
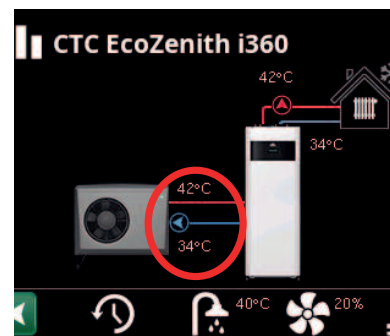

13.4 Pressure differential for heating medium side

The diagram below shows the total pressure differential for CTC EcoZenith i360 and the heat pump specified by the curve to the right of the diagram. Curves from the pump diagram on the previous page are added for reference.

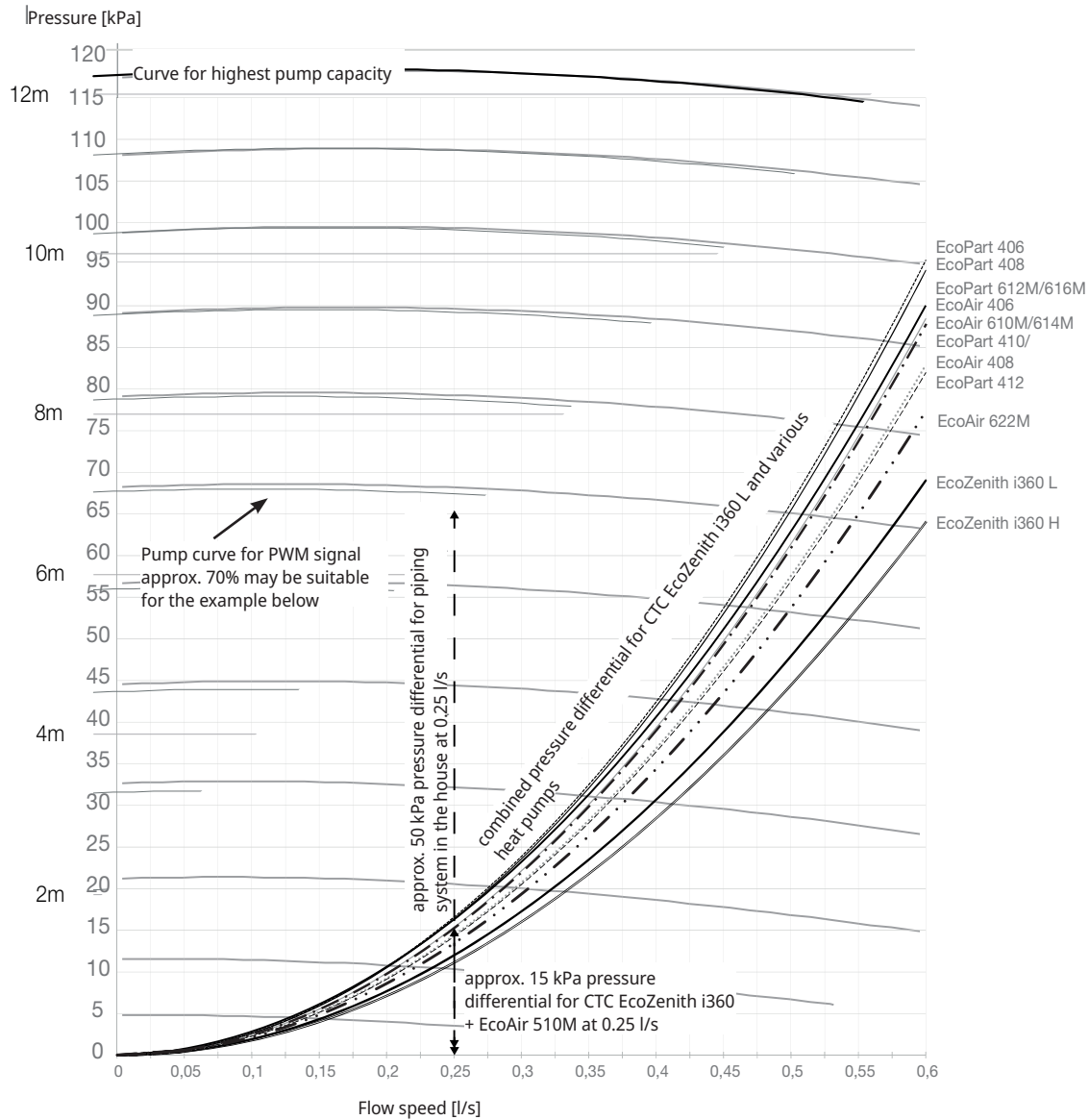

Example for calculating speed pump at required flow 0.25 l/s approx. 15 kPa pressure differential for EcoZenith i360 + EcoAir 610M at 0.25 l/s approx. 50 kPa pressure differential for piping systems in house at 0.25 l/s. The total pressure differential, over the heating circuit is approximately 65 kPa at 0.25 l/s. Compare against reference curves from the pump curve included in the diagram. Approx. 70% for PWM signal to charge pump may be a suitable setting.

Product	Kvs value	Product	Kvs value	Product	Kvs value
CTC EcoZenith i360 L	2.6	CTC EcoAir 610M/614M	5	CTC EcoPart 406	4.2
CTC EcoZenith i360 H	2.7	CTC EcoAir 622M	7.5	CTC EcoPart 408	4.3
		CTC EcoAir 406	4.9	CTC EcoPart 410	5.8
		CTC EcoAir 408	5.8	CTC EcoPart 412	6.0
				CTC EcoPart 612M	4.7
				CTC EcoPart 616M	4.7

13.5 Extra functions

There are many types of installation are possible with CTC EcoZenith i360. Several options are described here. For pipe installation, see the full schematic diagram or select combinations in the schematic diagram on our website.

13.5.1 Volume tank/equalisation tank

Connection options with volume tank, circulation pump (G1) and sensor (B1)

The heating circuit is extended with:

- CTC Volume tank
- Radiator pump (G1)
- Primary flow sensor (B1)

Aim: to achieve a sufficient flow speed for the building in the event of high energy needs and increased volume to avoid clicks in the radiator system.

If a volume increaser is needed, this requires an extra circulation pump (G1). For adjustment by degree minutes, install an extra primary flow sensor (B1). The product will then continue to calculate degree minutes in the heating circuit even if the heat pump is producing hot water or heating the pool.

Define radiator pump with the touchscreen:
Installer/Define/Define radiator pump (G1) – Yes.

Connection options with equalisation tank

The heating circuit is expanded with an equalisation tank.

Aim: to increase the water volume for defrosting the air-to-water heat pump and to counteract clicks in the radiator system, such as floor heating.

13.5.2 Electric shut-off valve Y47

For background heating in heating circuit 2, where the heating is switched off during the summer in heating circuit 1, an electric shut-off valve (Y47) may be installed. Terminal block A13 is powered during the heating season and not powered in the summer. Requires installation of primary flow sensor (B1), rad circulation (G1) and non-return valve or volume tank.

13.5.3 DHW circulation (accessory)

The settings for hot water circulation require the installation of an expansion card accessory.

DHW circulation is connected as shown in the schematic diagram. Pump G40 is used to circulate the hot water.

13.5.4 External heat source (EHS)

This function is used to connect additional heat sources to the heating circuit, e.g. water-jacketed stove, solar heat.

The heat from the external heat source is diverted into the system when the set temperature in the external tank is reached and is at least 5°C higher than the setpoint in the radiator system. Diversion stops when the temperature is 3°C higher. The compressor and immersion heater stay idle for as long as there is enough energy in the external heat source. Heat is diverted to both the heating circuit and to hot water.

This comes to an end when one of the following alarms occur: Primary flow sensor 1, HP in-sensor, Comm. error HP or if Primary flow sensor 1 is hotter than 80 °C.

Enter settings under “Settings/External heat source”.

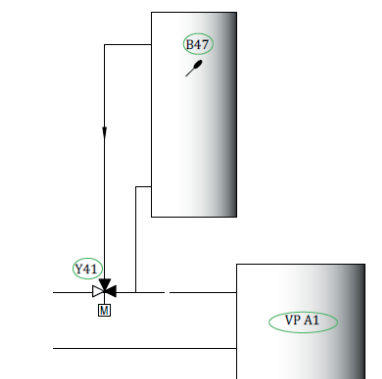
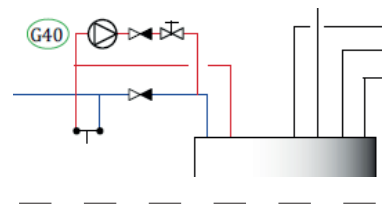
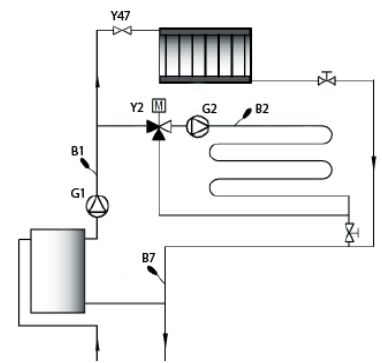
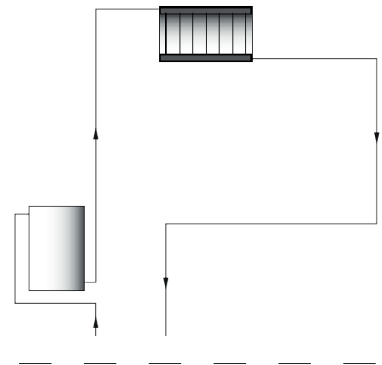
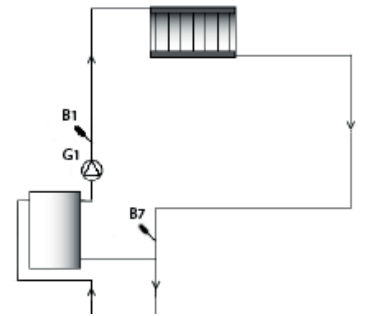

13.5.5 External Boiler

Aim: added heat when the need for heating or hot water is at its highest in winter, and for hot water when the need for heating is low if this is permitted. The function allows additional heat sources to be connected to the heating circuit with lower priorities (costlier heat sources), e.g. district heating or oil boilers.

Relay for external boiler (E1) is activated by outdoor temperature (or alarm). When the loss of degree minutes is great enough and the temperature is high enough (B9), the mixing valve (Y42) opens to the external boiler. Both the compressor in the heat pump and the immersion heater can be used at the same time as the external boiler. Heat is diverted to both the heating circuit and to hot water.

See more installation options in the menu description.

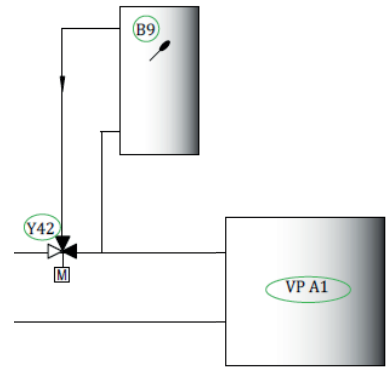

13.5.6 Diff thermostat function

The diff thermostat function is used to transfer heat from a tank with a sensor (B46) to a tank with a sensor (B47). The function compares the temperatures in the tanks and, when it is warmer in the first tank (B46), charging starts to the second tank (B47).

NB: For certain heat sources, e.g. solid fuel boilers, automatic chargers are recommended, among other things to counteract condensation in the fire box. However, this function cannot be combined with solar system 2 with EcoTank. This is because the same circulation pump (G46) is used.

"Operation data/Diff thermostat function" displays the information "Status (On/Off)".

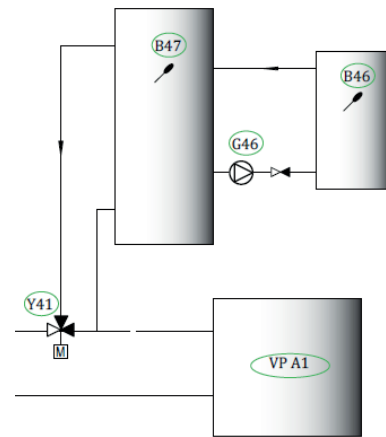

13.5.7 Pool (accessory)

A pool can be connected to the system using a 3-way valve (Y50). A heat exchanger should be fitted to separate the liquids. When the pool is heated, the 3-way valve (Y50) changes direction and the pool pump (G51) starts. The immersion heater is never used to heat the pool. When a constant flow is desired in the pool water, the pool pump (G51) is connected with a separate supply and constant voltage. The Extension Card accessory is required to connect pool heating to your heating circuit.

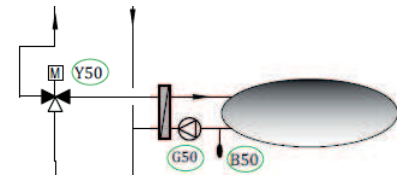

13.5.8 Solar heat (accessory)

Solar heat is connected to the system through an external heat source tank (EHS-tank).

The number of solar panels which can be connected depends on the volume of water in the product/tanks to which the solar panels are to be connected.

System 1

System 1 is a system structure with solar heat going directly to an external heat source tank (EHS-tank).

Charging conditions (main conditions, factory settings)

- Charging starts when B31 is 7°C warmer than B6.
- Charging stops when there is a difference of 3°C between B31/B30 or when the charge temperature is reached.

The tank for the external heat source (01) can also have a solar coil, in which case the heat exchanger (F2), pump (G32) and non-return valve (Y11) are not required.

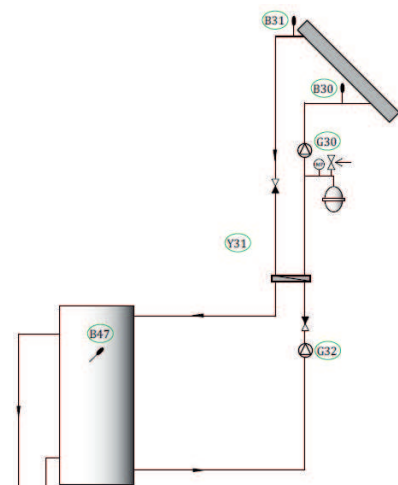

System 2

System 2 is a system structure with solar heat connected to an external heat source tank (EHS tank) and an extra buffer tank (CTC Volume tank for example). The system allows for a larger solar collector surface since it carries a greater volume of water.

Charging conditions

- Charging starts when B31 is 7°C warmer than B42.
- Buffer tank without coil:
- Charging stops when there is a difference of 3°C between B31/B30 or when the charge temperature is reached.
- Buffer tank with coil:
- For a tank with a solar coil, the charging stops instead when B31 is 3°C warmer than B42.
- Charging of the EHS tank compares sensor B41 to sensor B47.

The buffer tank (02) may also have a solar coil; this means that the heat exchanger (F2), pump (G32) or non-return valve (Y11) is not required.

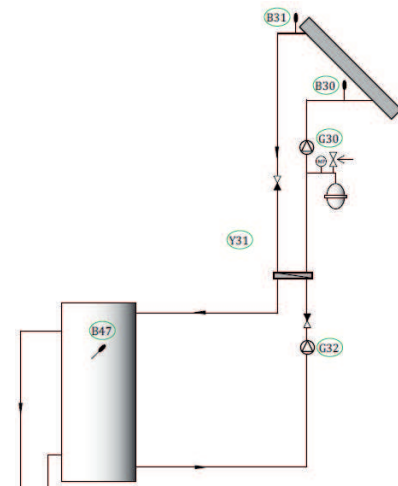

System 3

System 3 is a system structure with an extra volume called 03; this can be a large extra tank or a pool. The greater the water volume, the larger the solar collector surface required.

System 3 is solar heat connected to an external heat source tank (EHS-tank) and an extra buffer tank. The system allows for a larger solar collector surface since it carries a greater volume of water.

Charging conditions

- Charging starts when B31 is 7°C warmer than B42 or B47.
- Charging stops when there is a difference of 3°C between B31/B30 or when the charge temperature is reached.

13.5.9 CTC EcoVent (accessory)

To connect the CTC EcoVent ventilation product, please refer to the CTC EcoVent manual.

13.5.10 CTC SmartControl (accessory)

To connect CTC SmartControl, please refer to the CTC SmartControl manual.

13.5.11 Active cooling

Function

Active cooling is produced by the heat pump's compressor.

For cooling needs, the 3-way valve (Y61) is activated, whereby the cooling flow is routed via a cooling tank and on to the heating circuit (common system) or to e.g. a fan convector (separate system).

The mixing valve (Y2) controls cooling based on the current primary flow temperature (sensor B2) and return temperature (sensor B72).

Active cooling is controlled by primary flow sensor 2 (B2), which means that active cooling and heating circuit 2 cannot be used at the same time.

Active cooling can be defined together with External heat source/Diff. thermostat or External boiler because the functions share the same inputs and outputs on the relay card.

System solutions

Active cooling for common alternatively separate heating/cooling is presented on the following pages in four system solutions (1-4) where the electrical components to be installed and the preconditions for each system solution are indicated.

Common heating/cooling

In order to be able to utilise active cooling, you need to have an heating circuit to which cooling can be connected. If the heating circuit can be used for cooling the property, the heating circuit is used for heating in the winter and for cooling in the summer.

Separate heating/radiator system and cooling system (fan convector)

The controlling product can simultaneously manage a heating circuit for heating and a separate system for cooling. This can be relevant if you want to cool a part of the property using e.g. a fan convector at the same time as there is a need to heat another part.

Automatic heating/cooling function

Once the setting is made, operation is completely automatic. The control system automatically ensures that the property is heated when there is a heating demand and cooled when there is a cooling demand, without the systems clashing.

Condensation

Condensation forming can be a problem if the system is not condensation proof.

Block cooling can be controlled remotely. For example, the function can be used to turn off cooling with the help of a humidity sensor when there is a risk of condensation. See also the "Settings Cooling" section of the "Control system" chapter.

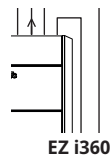

EZ i360

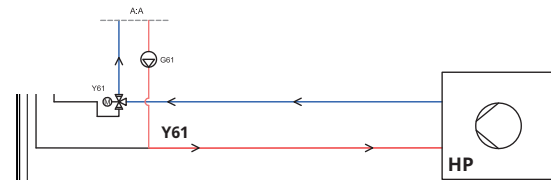

Heat pump and indoor module.

See system solutions 1-4 for connection of different active cooling systems.

System 1

Preconditions:

- No secondary heating requirement for cooling needs.
- No degree minute calculation.
- No need for buffer volume*.

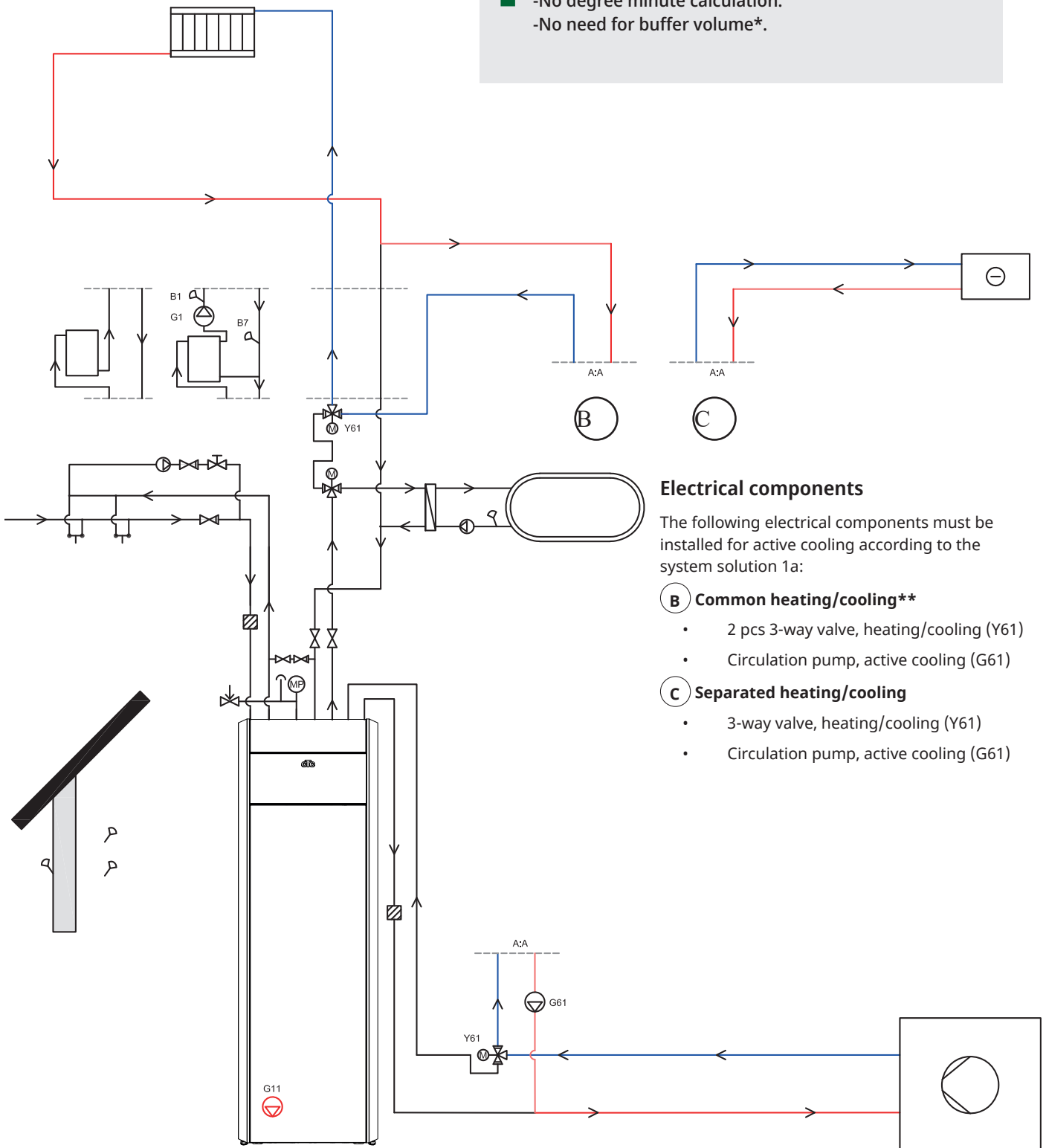

Electrical components

The following electrical components must be installed for active cooling according to the system solution 1a:

B Common heating/cooling**

- 2 pcs 3-way valve, heating/cooling (Y61)
- Circulation pump, active cooling (G61)

C Separated heating/cooling

- 3-way valve, heating/cooling (Y61)
- Circulation pump, active cooling (G61)

**In the case of a common heating/cooling option, (A) the water flow is led through the indoor module. However, at system temperatures below 18 °C, it is recommended to bypass the indoor module.

With this option, no electrical components are added during installation.

*See system volume requirements in the respective heat pump manual.

System 2

Preconditions:

- Secondary heating requirement for cooling needs.
- Degree minute calculation.
- No need for buffer volume*.

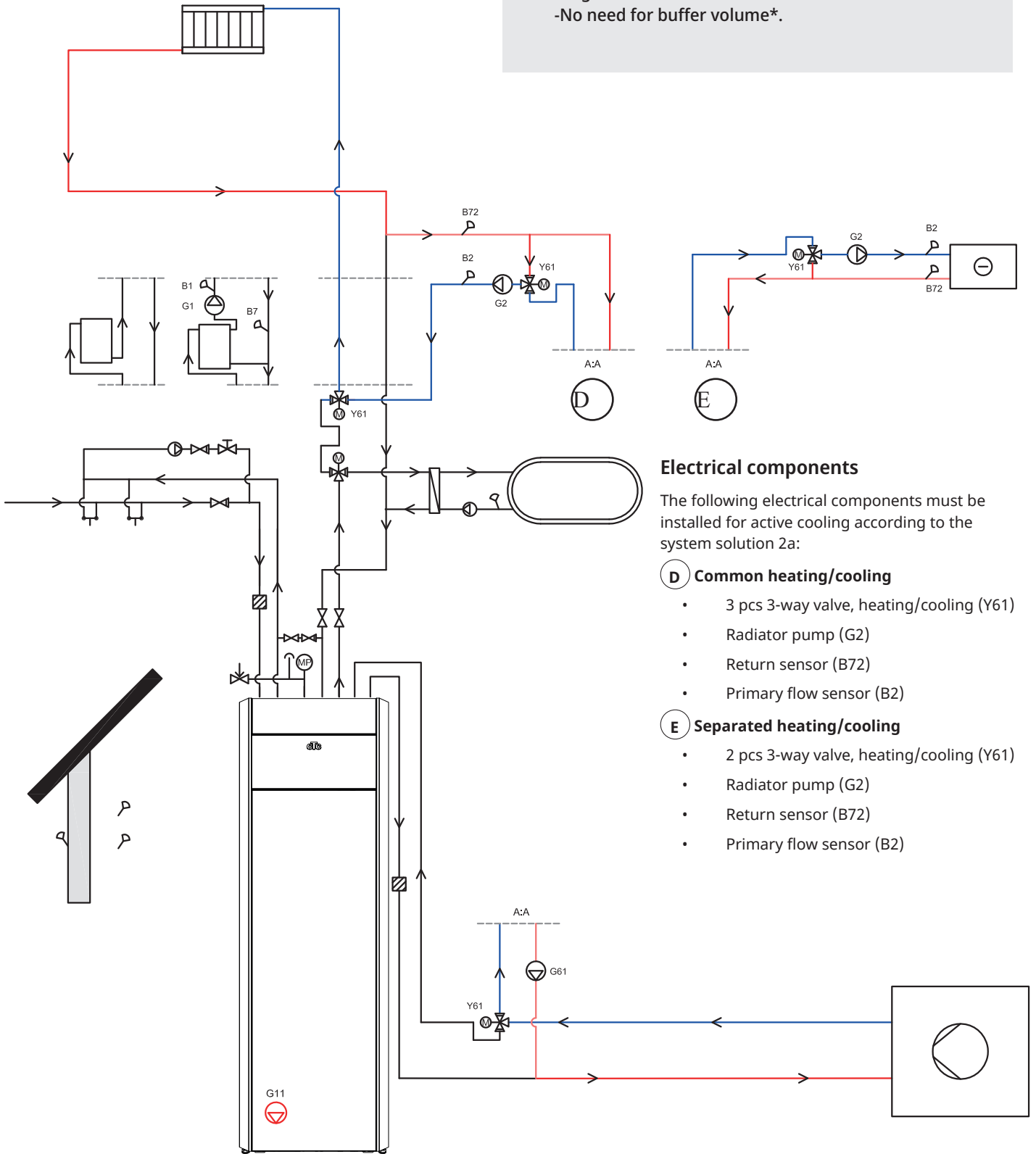

Electrical components

The following electrical components must be installed for active cooling according to the system solution 2a:

D Common heating/cooling

- 3 pcs 3-way valve, heating/cooling (Y61)
- Radiator pump (G2)
- Return sensor (B72)
- Primary flow sensor (B2)

E Separated heating/cooling

- 2 pcs 3-way valve, heating/cooling (Y61)
- Radiator pump (G2)
- Return sensor (B72)
- Primary flow sensor (B2)

*See system volume requirements in the respective heat pump manual.

System 3

Preconditions:

- Secondary heating requirement for cooling needs.
- Degree minute calculation.
- System volume not sufficient; buffer volume* must be added.

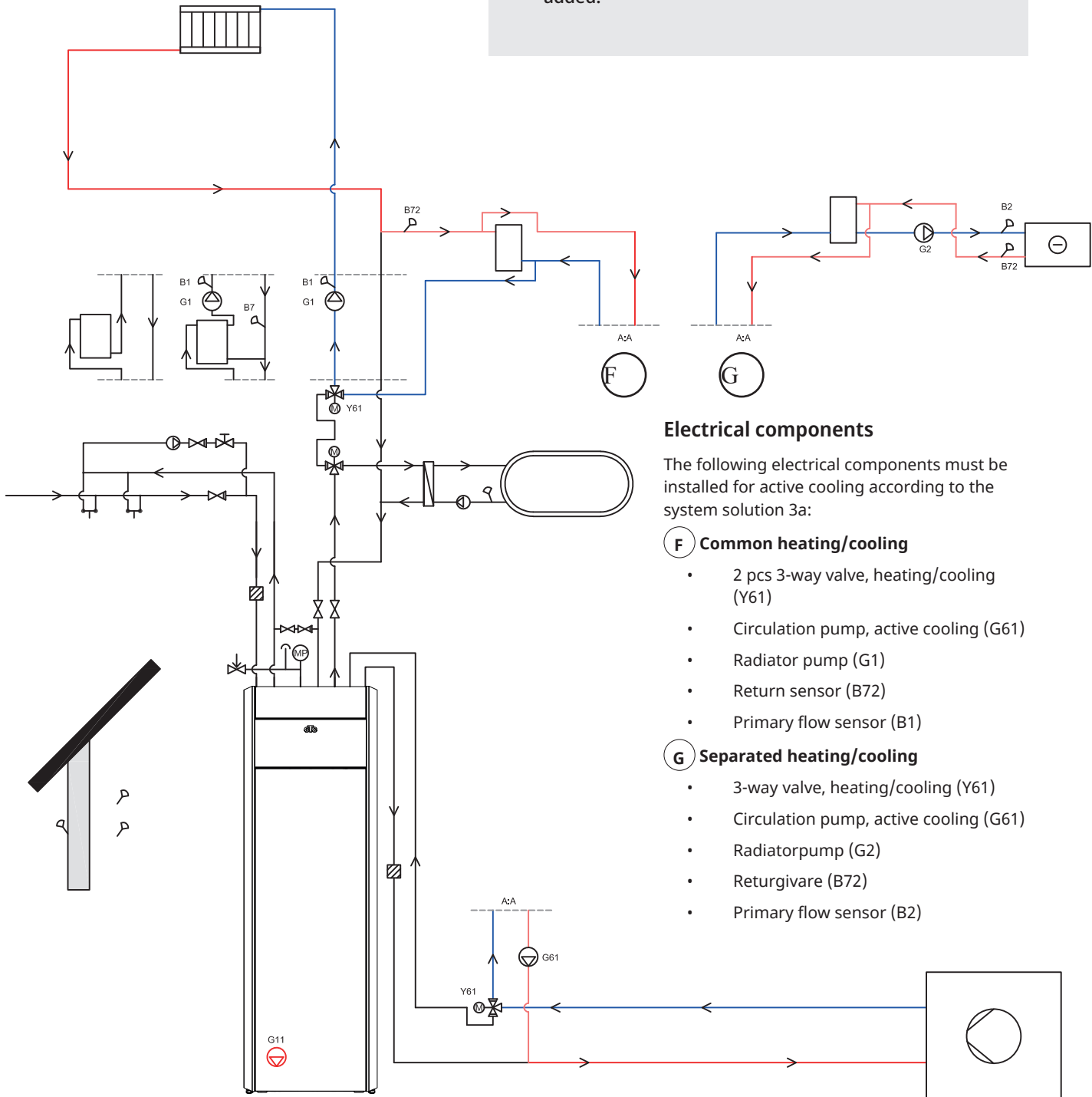

Electrical components

The following electrical components must be installed for active cooling according to the system solution 3a:

F Common heating/cooling

- 2 pcs 3-way valve, heating/cooling (Y61)
- Circulation pump, active cooling (G61)
- Radiator pump (G1)
- Return sensor (B72)
- Primary flow sensor (B1)

G Separated heating/cooling

- 3-way valve, heating/cooling (Y61)
- Circulation pump, active cooling (G61)
- Radiator pump (G2)
- Return sensor (B72)
- Primary flow sensor (B2)

*See system volume requirements in the respective heat pump manual.

System 4

Preconditions:

- Secondary heating requirement for cooling needs.
- Degree minute calculation.
- System volume not sufficient; buffer volume* must be added.
- Storage of cooling in the extra tank (cooling tank).

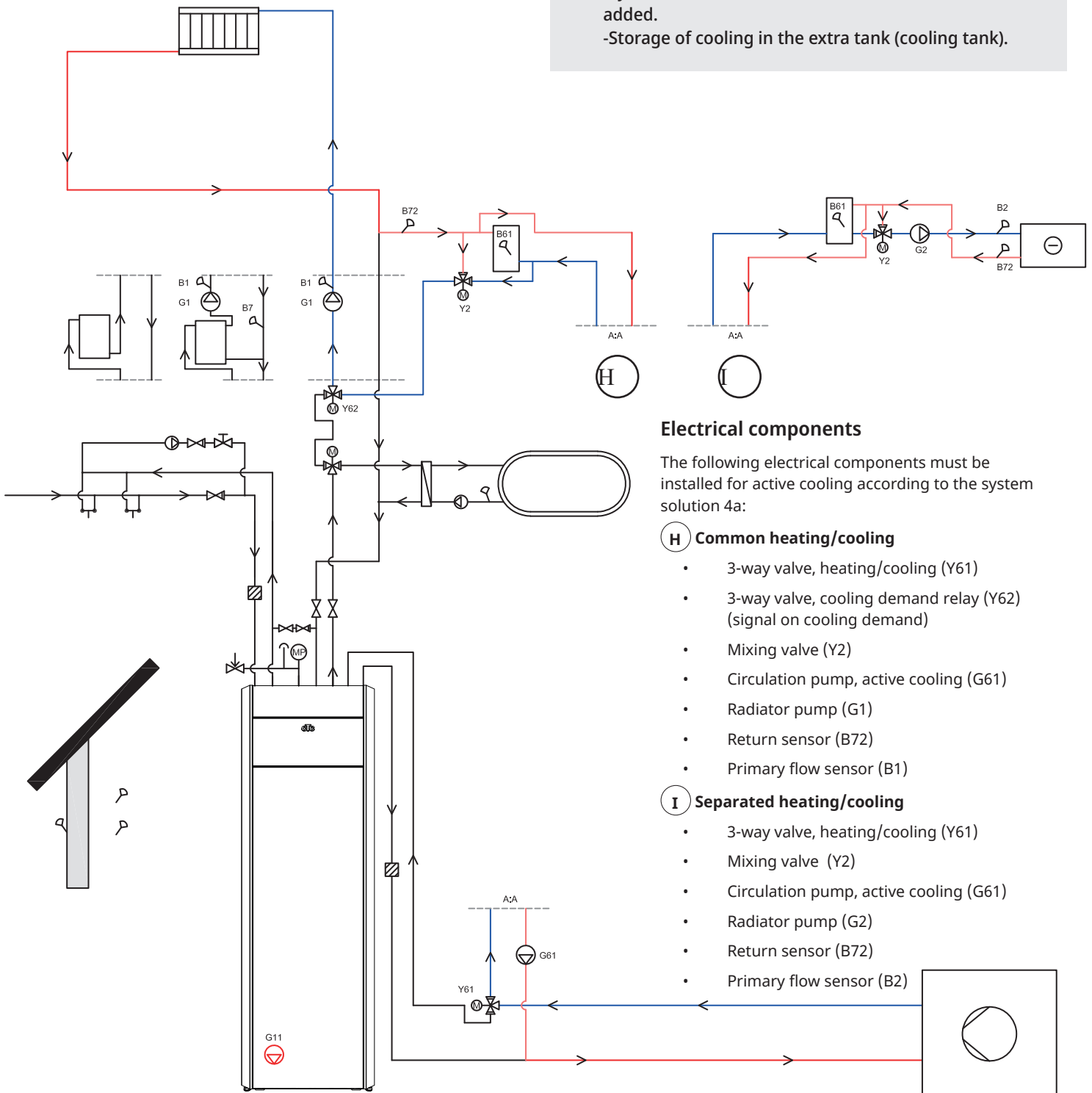

Electrical components

The following electrical components must be installed for active cooling according to the system solution 4a:

(H) Common heating/cooling

- 3-way valve, heating/cooling (Y61)
- 3-way valve, cooling demand relay (Y62) (signal on cooling demand)
- Mixing valve (Y2)
- Circulation pump, active cooling (G61)
- Radiator pump (G1)
- Return sensor (B72)
- Primary flow sensor (B1)

(I) Separated heating/cooling

- 3-way valve, heating/cooling (Y61)
- Mixing valve (Y2)
- Circulation pump, active cooling (G61)
- Radiator pump (G2)
- Return sensor (B72)
- Primary flow sensor (B2)

*See system volume requirements in the respective heat pump manual.

13.5.11.1 Control logic, consumer

The control logic for the consumer is described below. See the "Settings Cooling" section of the "Control system" chapter for more information about relevant menu settings.

Active cooling must be defined in the "Installer/Define/Cooling" menu in order to be activated as shown below.

Common heating/cooling

Active cooling in a common system is permitted if the following criteria are met at the same time:

- the delay time has passed after the production of heat has ended.
--> see menu bar "Heating off, delay".
- the outdoor temperature exceeds (or is equal to) the temperature from which cooling is to be permitted.
--> see the "Cooling permit. from outdoor T °C" menu.

Non-common heating/cooling

Active cooling in a separate system is permitted if the following criteria are met at the same time:

- the outdoor temperature exceeds (or is equal to) the temperature from which cooling is to be permitted.
--> see the "Cooling permit. from outdoor T °C" menu.

Room sensor installed

If a room sensor has been installed, active cooling is permitted if the following criteria are met at the same time:

- the room temperature exceeds (or equals) the set value plus the set temperature diff.
--> see the "Room temp cooling °C" menu.
--> The temperature diff. is set in the "Service/Coded settings" menu.
- when the delay time has passed.
--> see the "Start delay" menu.

Active cooling is stopped when the room temperature is less than (or equal to) the set stop temperature minus the set temperature diff.

Room sensor not installed

- Cooling is activated when the delay time has passed.
--> see the "Start delay" menu.

Block cooling

- Cooling can be temporarily deactivated by blocking cooling externally without any effect on delays.
--> see the "Ext. block cooling" menu.

Primary flow temperature

- The minimum primary flow temperature is calculated from the value set for the primary flow temperature at outdoor temperatures of +20 °C and +40 °C respectively.
--> see the "Primary flow temp at outdoor +20 °C/+40 °C" menus.
- The estimated diff. is calculated from the diff. set value permitted between the primary flow and return temperature of the cooling flow at outdoor temperatures of +20 °C and +40 °C respectively.
--> see the "Primary flow diff. outdoor +20 °C/+40 °C" menus.

Every x minutes, a new primary flow temperature is calculated based on the return temperature.
--> see the "Diff delay calc." menu.

If the value is lower than the minimum primary flow temperature, then this sets the minimum primary flow temperature.

Mixing valve control is calculated from the current and estimated primary flow temperature.

13.5.11.2 Alarm logic cooling

An alarm is triggered if:

- The cooling flow temperature is lower than the set value (factory setting: 18°C) minus 0.5 °C.
The value is set on the menu bar "Min. flow temp cooling" in the "Installer/Service/Coded settings/Cooling" menu.

or

- For a common system: the primary flow temperature is lower than the room temperature minus the set flow diff. (factory setting: 5°C) minus 0.5 °C.
The "flow diff." value is set on the menu bar "Max diff. room temp cooling" in the "Installer/Service/Coded settings/Cooling" menu.

If any of the conditions are met for 10 minutes, the mixing valve (Y2) closes for 5 minutes. The mixing valve is permitted to control the system for a total of 30 minutes. If the error persists after this time, the alarm will be triggered and appear in the display on the start menu.

14. Control system

14.1 Navigate on the touchscreen

14.2 Start menu

This menu is the system’s home screen. This provides an overview of the current operation data. The system returns to this menu if no buttons are pressed within 10 minutes. All other menus can be accessed from this menu.

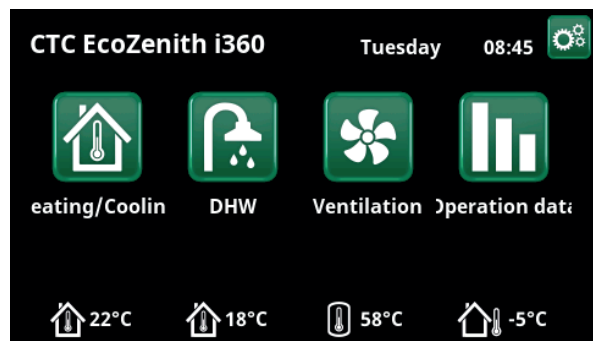

14.3 Alarm management

Signal	Status
Green LED	OK.
Red/yellow flashing LED	Alarm.
Green flashing LED	Operation with active immersion heater - Applies only with language selection "Danish".
Info message at bottom	Information message about the current status

- Refer to the troubleshooting table at the end of the installation manual.
- Call your installation engineer in the first instance

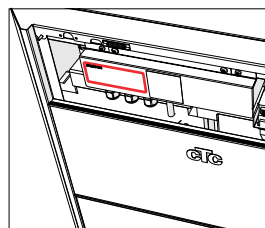

The serial number (12 digits) can be found behind the magnetic strip. This number is needed to be given to the installation engineer and CTC support in the event of a fault report.



14.4 Heating/Cooling

In the menu "HC- Heating/Cooling" the following settings can be made:

14.4.1 Setpoint setting with room sensor

Set the desired room temperature (set point) with the "minus" and "plus" buttons. In the example in the "HC1 Heating/Cooling" menu, the "Economy" programme and "Holiday mode" (V) are active for heating circuit 1.

In the "HC2 Heating/Cooling" menu, the "Cooling" mode is active.

"Holiday mode" and "Night reduction" only lower the room temperature when heating mode is active.

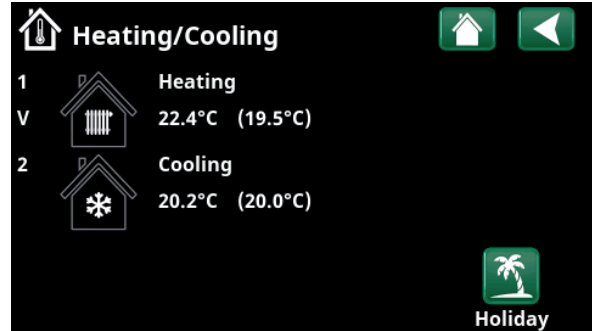

Click on heating circuit 1 or 2 to go to the menu of the respective heating circuit. In this menu you can activate "Holiday mode" for the heating circuits.

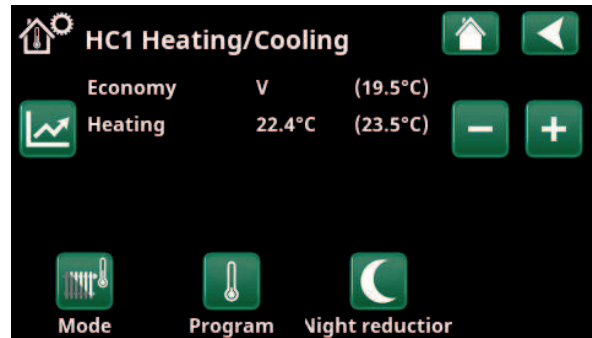

In the menu, programs "Economy" and "Holiday mode" (V) are active for heating circuit 1. In this example, both the "Economy" and "Holiday Mode" programmes are set to lower the set point (23.5 °C) by 2 °C, which means that the actual set point = 23.5 - 2 - 2 °C = 19.5 °C.

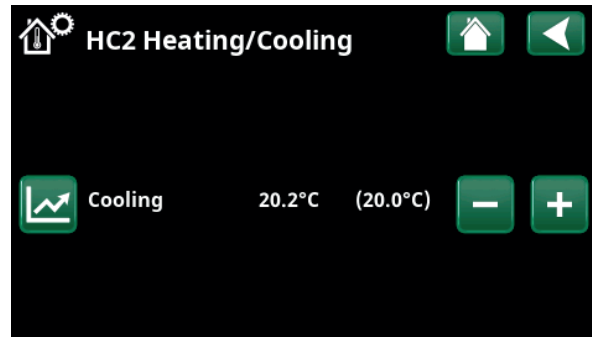

In the menu, "Cooling" (setpoint: 20.0 °C) is active for heating circuit 2. "Holiday mode" (V) does not lower the setpoint when cooling is active.



14.4.2 Program

Press the "Program" button and the heating program to be activated (Economy, Normal, Comfort or Custom). It is also possible to schedule the programmes.

See chapter "Installer/Settings/Heating circuit/Program" for information on how to set temperature increases/decreases and delay times for the programs.

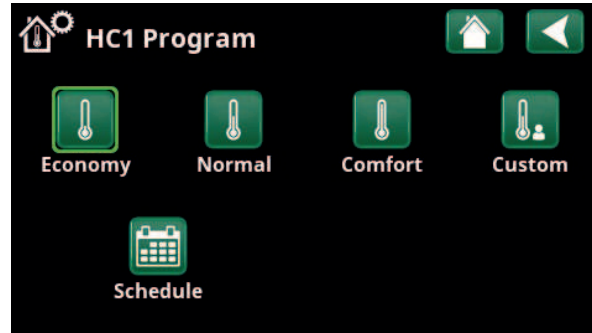

Menu "HC1 Heating/Cooling / HC1 Program" where program "Economy" has been activated.



14.4.3 Heating/Cooling curve

Press the heating/cooling curve symbol in the "HC1-Heating/Cooling" menu. The graph of the heating/cooling curve of the heating circuit is displayed.

The chapter "Installer/Installation/Heating circuit" describes the setting of the heating/cooling curve.

See also chapter "House heating curve" for more information on adjusting the heating curve.

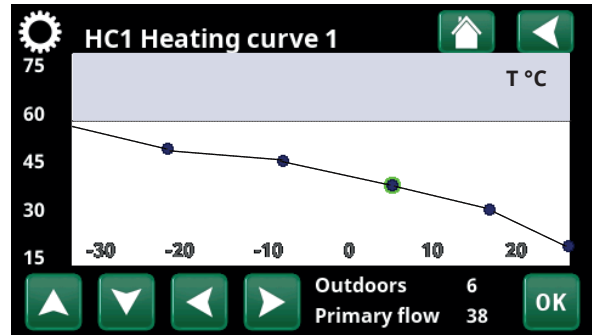

Menu "Heating/Cooling/HC1 Heating/Cooling".



14.4.4 Heating mode

Press the "Mode" button and then select "Heating mode"; "Auto", "On" or "Off".

Heating mode can also be selected in the menu "Installer/Settings/Heating circuit/Heating mode".

See chapter "Installer/Settings/Heating circuit" for more information.

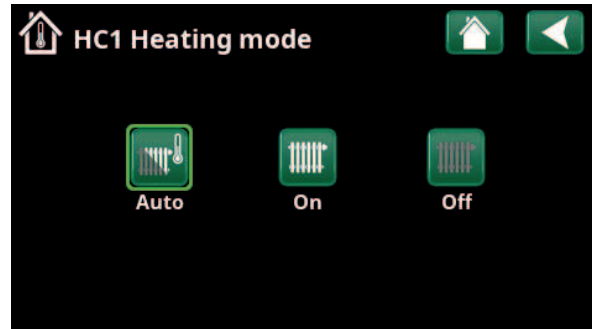

Menu "HC1 Heating/Cooling/HC1 Heating mode" where mode "Auto" has been activated.

14.4.5 Room temperature setting without room sensor

You can select "Room sensor - No" in the "Installer/Define/Heating circuit" menu. This is used if the room sensor is difficult to place, if the underfloor heating system control has its own room sensor or if you are using a wood-burning stove/fireplace. The alarm LED on the room sensor works as usual.

If a wood-burning stove or fireplace is used sporadically, the burning may cause the room sensor to reduce the temperature of the heating circuit and it may become cold in the rooms in other parts of the house. The room sensor can then be temporarily switched off during firing and the heat pump provides heat to the heating circuit according to the set heating curve. The radiator thermostats are throttled in the part of the house where the fire is burning.

If the room sensor has not been installed, the heating must be set according to the chapter "House heating setting".

14.4.6 Outdoor sensor/room sensor errors

If a fault occurs with an outdoor sensor, the product triggers an alarm and an outdoor temperature of -5 °C is simulated so that the house does not get cold.

If a fault occurs with a room sensor, the product triggers an alarm and automatically switches to operating according to the set curve.

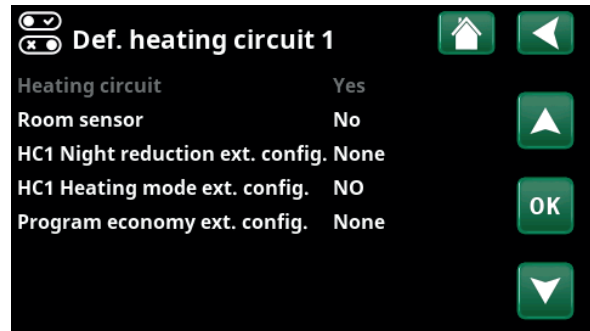

Menu "Installer/Define/Heating circuit/Heating circuit 1".

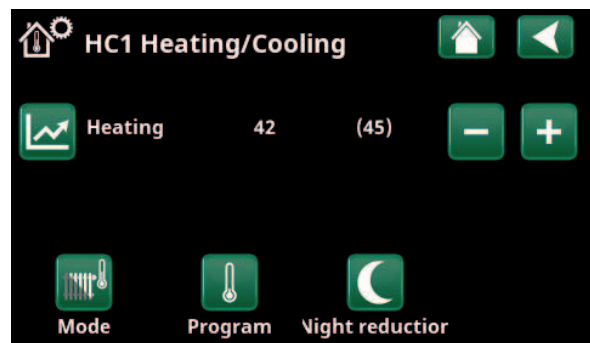

Menu "Installer/Define/Heating circuit/Heating circuit 1". The heating circuit has no room sensors. The setpoint (primary flow temperature 45 °C) is shown in brackets, the current primary flow temperature 42 °C is shown to the left of the setpoint.



14.4.7 Night Reduction Temperature

Night reduction means reducing the temperature indoors, via remote control or during scheduled periods.

In the menu "HC1 Night reduction" menu, the periods during the week for night temperature reduction can be scheduled.

The "Night reduction" icon in the "Heating/Cooling" menu only appears if a "Schedule" has been defined for the heating circuit in the "Installer/Define/Remote control" menu.

The "Schedule" chapter describes how to set schedules.

The value by which the temperature is reduced during remote control of the night reduction is set in one of the following menus.

Room sensor installed:

"Installer/Settings/Heating circuit/Room temp reduced night red °C".

Room sensor not installed:

"Installer/Settings/Heating circuit/Prim. flow reduced night red °C".

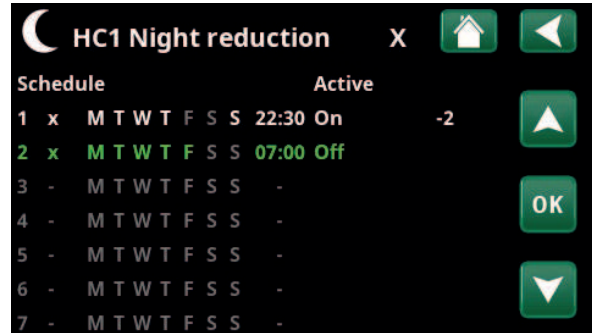

The schedule has been set for "Night Reduction" to be active weekdays between 22:30 and 07:00, except during the night between Friday and Saturday and the night between Saturday and Sunday (when no night reduction occurs).

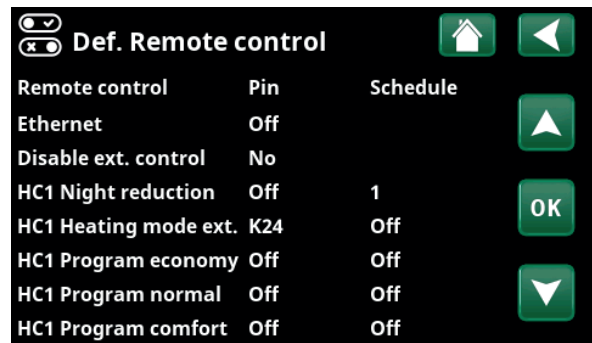

Menu: "Installer/Define/Remote Control".
The "HC1 Night Reduction" function is assigned to Schedule #1.



14.4.8 Holiday

This option is used to set the number of days that you want continuous reduction of inside temperature, for example if you want to go on holiday.

The value by which the temperature is reduced during the period is set in one of the following menus:

Room sensor installed:

"Installer/Settings/Heating circuit/Room temp reduced holiday °C".

Room sensor not installed:

"Installer/Settings/Heating circuit/Prim. flow reduced holiday °C".

Holiday reduction is enabled from the time of setting (press the plus (+) sign).

Up to 300 days can be set.

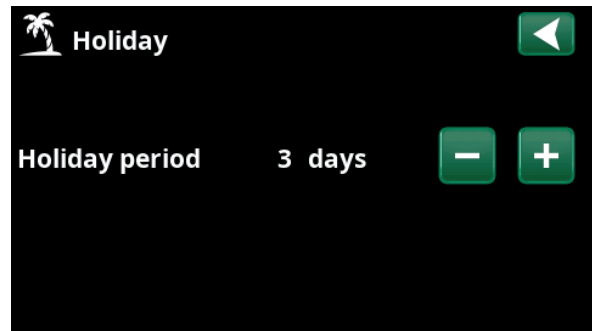

When holiday is enabled, hot water production is stopped. The "Temporary extra DHW" feature is also stopped.

When both "Night Reduction" and "Holiday Reduction" are in use, "Holiday Reduction" supersedes "Night Reduction".



14.5 DHW

This menu is used to set the hot water comfort level and "Extra DHW".

Extra DHW

The "Extra DHW" function can be activated here. When the function is activated (by setting the number of hours using the plus sign in the "Hot Water" menu), the heat pump immediately starts to produce extra DHW. It is also possible to remotely control or schedule hot water production according to specified times.

DHW mode

You set the values for this option which apply to the heat pump's normal operation. There are three modes:



Economy

For low hot water needs.
(Factory value stop temperature DHW tank: 50 °C).



Normal

Normal hot water needs.
(Factory value stop temperature DHW tank: 55 °C).



Comfort

For high hot water needs.
(Factory value stop temperature DHW tank: 58 °C).

14.5.1 Extra DHW

You can use this menu to schedule periods during weekdays when you want extra DHW. This schedule is repeated every week.

The stop temperature for Extra DHW is 60 °C (factory setting).

The "Schedule" chapter describes how to set schedules.

Click the "Extra DHW" heading to obtain a graphical overview of when the schedule is active during weekdays.

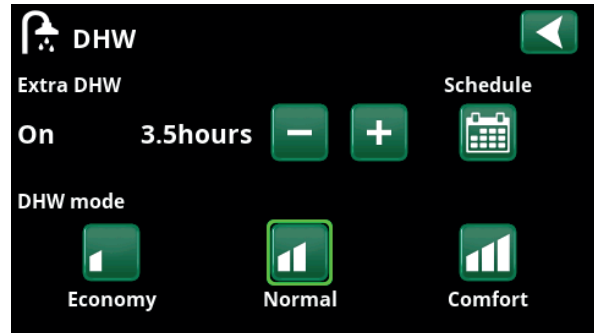

The "Extra DHW" function is set to be active for 3.5 hours.

NB: Set the time approx. 1 hour earlier than when you need the hot water as it may take some time to heat-up.

Tip: Set to "Economy" mode from the start. If the hot water is deemed insufficient, raise to "Normal" mode, and so on.

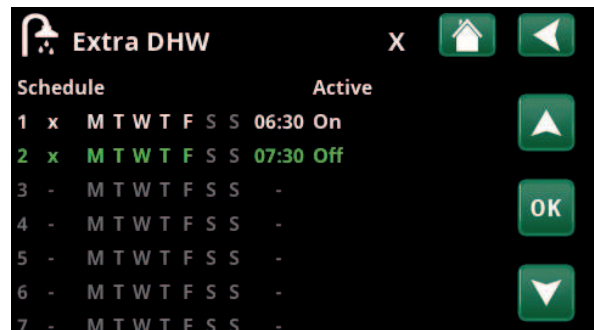

The "Extra DHW" function is set to be active on weekdays between 06:30 and 07:30.

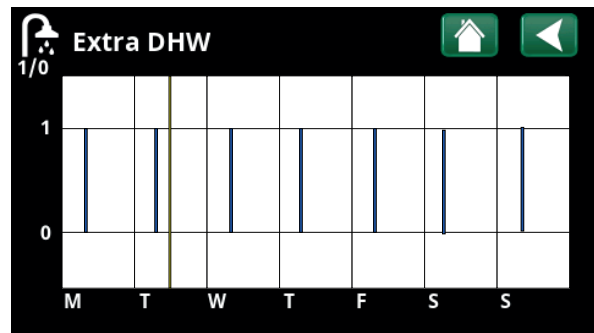

Use the Back button to switch between settings and preview. A vertical blue bar indicates when "Extra DHW" is active. A horizontal yellow line indicates the current time. The X axis represents the days, Monday to Sunday.



14.6 Ventilation

Refer to the "Installation and Maintenance Manual" for the CTC EcoVent ventilation product.

14.7 Schedule

In a Schedule, the periods can be set for when a function should be active or inactive during the weekdays.

The system does not allow certain functions to be active at the same time on the same schedule; for example, the "Night Reduction" and "Extra DHW" functions, but most functions can share the same schedule.

If several functions share the same schedule, changes to the schedule for one function will cause the same changes for the other functions that share the schedule.

To the right of the schedule header, an "X" will appear if the same schedule is also shared by another remote control function.

Click on the schedule's header row to see a graphical overview of when the schedule is active during the days of the week.

14.7.1 Defining a schedule

In this example, a night temperature reduction of heating circuit 1 (HC1) is programmed.

First, a schedule must be defined in the "Installer/Define/Remote control" menu.

Enter a schedule (1-20) in the "Schedule" column in the "HC1 Night Reduction" row using the arrow keys, or click where the cursor is in the example.

14.7.2 Schedule settings

A schedule can be set for most remotely controlled functions in the menus under "Installer/Settings".

However, schedules for "Night reduction", "Extra DHW" and "Ventilation" can only be accessed via the start menu.

The schedule includes 30 rows and a setting can be made in each row. For example, in one row you can set the date and time for the function to activate, and the time the function should deactivate in the row below.

In the example, "Night reduction" for heating circuit 1 has been set to be "On" from 22:30 to 07:00 on weekdays, except for weekends (Friday and Saturday nights).

The second row is highlighted green, which means that row is active at the current time.

Schedule **Active**
(Active/Inactive/Restore factory settings)

Activate the schedule by setting it to "Active" mode. It is also possible to restore factory settings.

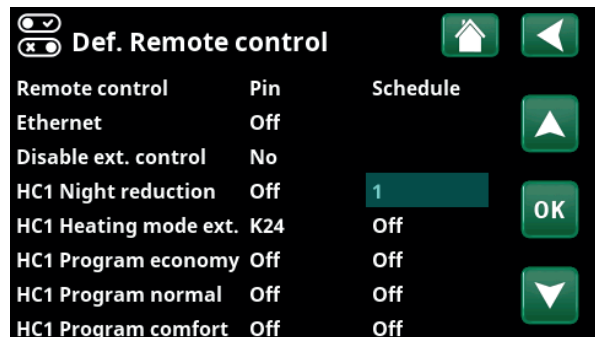

Menu: "Installer / Define / Remote Control".

The "HC1 Night Reduction" function is assigned to Schedule #1.



Click on the "Night Reduction" icon in the heating circuit "Heating/Cooling" menu to set the schedule.

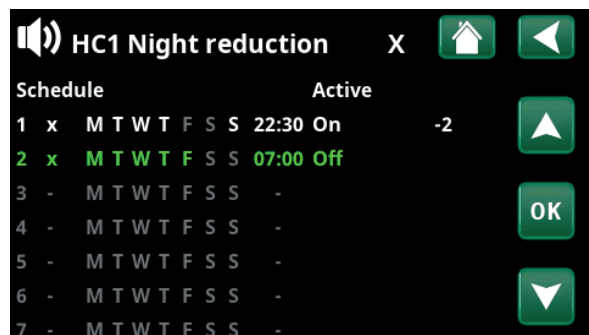

The schedule has been set for "Night Reduction" to be active weekdays between 22:30 and 07:00, except during the night between Friday and Saturday and the night between Saturday and Sunday (when no night reduction occurs).

14.7.3 Editing a schedule

Go down to the first row and press "OK" to enable editing mode.

Time

Use the arrow keys to change the time (hours and minutes, respectively).

Day by day

Use the arrow keys (up arrow /down arrow) to mark active days in bold.

Action Off (On/Off)

This normally indicates whether the row will switch the function "On" or "Off".

However, for the "Night Reduction" and "SmartGrid Schedule" functions, the following applies:

- In the schedule for "Night Reduction", the temperature reduction that will apply during the period is specified in °C here instead. When a temperature is specified (setting range -1 to -30 °C), the status of the row automatically switches to "On".
- When setting a "SmartGrid schedule", the SmartGrid function (SG Block., SG Low price and SG Overcapacity) is specified in the "Action" row. The status of the row automatically switches to "On".

Active Yes (Yes/No)

"Yes" means that the row is activated.

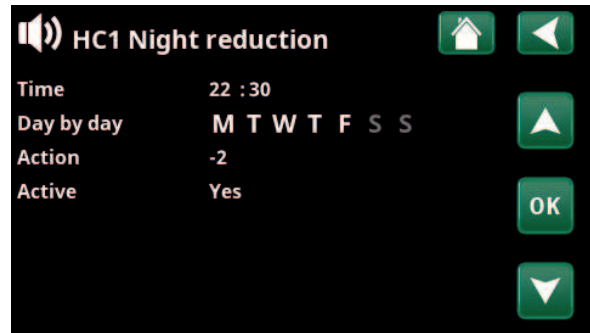

Setting the Night Reduction (-2 °C), weekday nights.

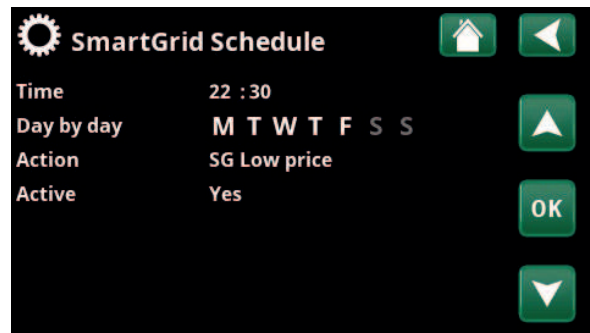

The SmartGrid function "SG Low Price" is scheduled for weekdays 22:30-06:00. Go to the menu by selecting "SmartGrid schedule" in the "Installer/Settings" menu.



14.8 Operation data

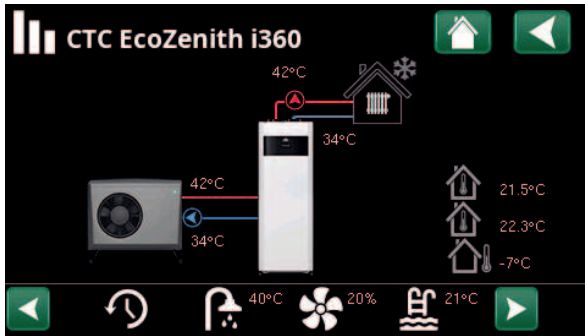

The screen shows operational data with the CTC EcoAir connected. When the pumps are in operation, the pump icons also rotate on screen.

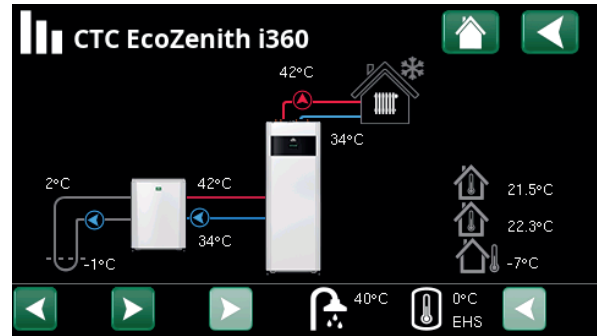

The screen shows operating information with the CTC EcoPart connected. When the pumps are in operation, the pump icons also rotate on screen.



Outside temperature

Measured temperature, outdoor sensor.



Indoor temperature

Shows the room temperature for defined heating circuits (room sensors 1 and 2).



Brine temperature

Current temperature (2 °C) of the brine from the collector in the heat pump and return temperature (-1 °C) of the brine back into the collector hose.



Heating circuit

Current primary flow temperature (42 °C) to the house is shown on the left. Current return temperature (34 °C) is shown below.



Heat pump, air-to-water

The air-to-water heat pump is connected and defined for the circuit. The in and out temperatures of the heat pump are shown on the right.



Heat pump, liquid-to-water

The liquid-to-water heat pump is connected and defined for the circuit. The in and out temperatures of the heat pump are shown on the right.

The icon bar at the bottom of the menu page displays icons for additional functions or subsystems that have been defined.

Scroll using the arrows or swipe in the list if not all the icons fit on the page.



Ventilation



Pool



Solar Panel



External Boiler



DHW



History



Diff. thermostat function



External Heat Source (EHS)

The gear icon is a shortcut to "Settings" for the respective part.





14.8.1 Operation data, Control unit

Status HS

Current charging mode, see table below.

DHW tank °C 49, 45 (55)

Shows the hot water temperatures in the upper and lower parts of the tank. The value in brackets is the setpoint (stop temperature). The set point is set for the top of the tank.

DHW °C 48 (50)

Shows current DHW temperature and setpoint (in brackets). If no hot water is drawn then no temperature is shown, just the setpoint.

Capacity 92%

Shows the estimated amount of energy remaining for DHW.

Degree minute -1000

Shows current heat loss in degree minutes.

Cooling tank °C 0 (--)

Shows current temperature and (setpoint) in the cooling tank.

Degree minute cooling* 0

Shows the current deficit of cooling in the heating system (measured in degree minutes).

Electric power kW 0.0

Shows instantaneous power from the immersion heater.

Current L1/L2/L3 A 8.6 9.1 8.9

Total current consumption of the house at the various phases L1/L2/L3, provided that three current sensors have been fitted to incoming cables in the house. If the current sensors mounting devices are not identified, only the phase with the highest load is displayed.

If the current exceeds the main fuse size, the boiler automatically switches down a power step to protect the fuses, for example, when several high-consumption appliances are being used in the house.

Three values are displayed for "Current" when the current transformers are connected and identified. If only one digit is displayed:

- connect all three current transformers.
- then select in the "Installer/Service/Check current sensors" menu.

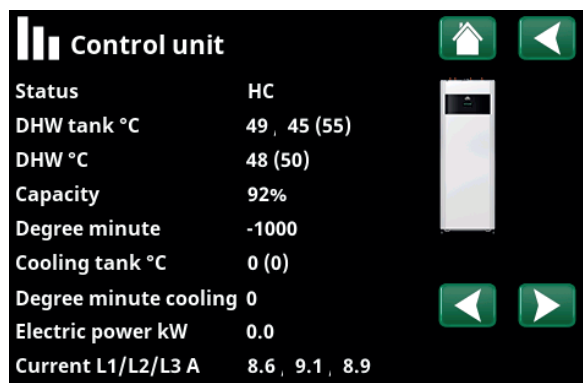

Menu Operation Data/Control Unit.

i The first figure is the current operating value. The value in brackets are the setpoint that the CTC EcoZenith is trying to achieve.

i "Degree minutes" refers to the product of the cumulative heat loss in degrees (°C) and the time measured for this in minutes.

*The menu bar is displayed if active cooling is defined in the menu "Installer/Define/Cooling".

- Cooling: Active
- Common Heating/Cooling: No
- Cooling tank: No

Control unit status	
HC	The heat pump charges the heating circuit.
DHW	The heat pump charges the DHW system.
Pool	The heat pump charges the pool.
Cooling	The heat pump charges the cooling tank.
Off	No heating takes place.
Alternating	The heat pump switches position to/from cooling.



14.8.2 Operation data, Heating circuit*

Click on a heating circuit to see more detailed operation data in a new menu window.

Mode **Custom**

Shows the active DHW program.

Status **Heating**

Shows the operational status of the heating circuit. See the table below.

Primary flow °C **42 (48)**

Shows the temperature supplied to the current heating circuit and the setpoint in brackets.

Return flow °C **34**

Shows the temperature of the water returning from the heating circuit to the heat pump.

Room temp. °C **21 (22) (25)**

Shows the room temperature for the heating circuit if room sensor installed. In brackets, the setpoint is shown for the "Heating" and "Cooling" status.

Radiator pump **Off**

Shows the operational status of the radiator pump ("On" or "Off").

Mixing valve **Open <50%**

Only displayed for Heating circuit 2.

Shows whether the mixing valve increases (opens) or decreases (closes) the heating flow to heating system 2 and when the mixing valve is in the "<50%" or ">=50%" position.

SmartGrid **Off**

Shows the status of the SmartGrid functions for the selected heating circuit.

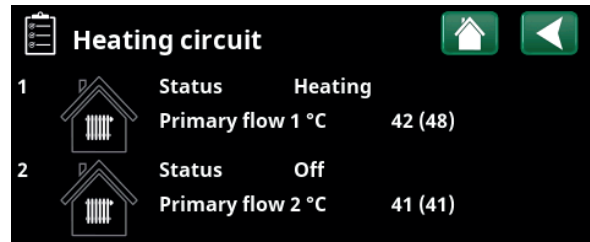

Menu: "Operation data, heating circuit". The menu shows the current temperatures and status of defined heating circuits.

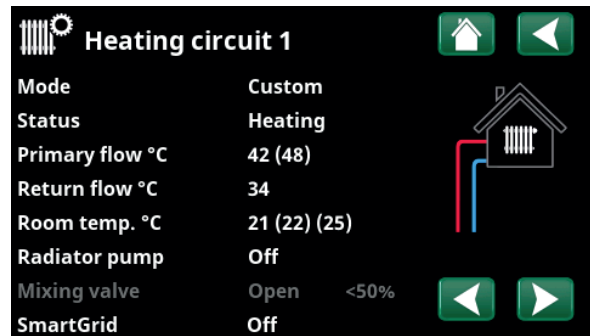

The menu shows detailed operation data of the selected heating circuit. Click the arrows or swipe sideways to view defined heating circuits.

*The heat pump can control up to 2 heating circuits.

Heating circuit status	
Heating	Heat is produced for the heating circuit.
Cooling	The system produces passive cooling.
Holiday	"Holiday reduction" of room temperature is active. For more information, refer to the "Heating/Cooling" chapter.
Night reduction	"Night reduction" of room temperature is active. For more information, refer to the "Heating/Cooling" chapter.
Off	No heating/cooling produced.



14.8.3 Operation data, Heat pump (air-to-water)

Status **On, heating**

Heat pump status, see table below.

Model **EcoAir 622M**

Shows the heat pump model.

Compressor **65RPS R**

Shows the compressor speed. "R" stands for "Reduced Mode" (for example, during "Silent Mode").

Charge pump **On 68%**

Shows operating status of the charge pump ("On" or "Off") and the flow in percent (0-100).

Fan **On 80%**

Shows operating status of the fan ("On" or "Off") and the fan speed in percent.

HP in/out °C **35.5 / 42.3**

Shows the heat pump's incoming and outgoing temperatures.

Outdoor temperature °C **3.0 (-50...50)**

Shows outdoor temperature.

Defrost timer **30**

Shows the time remaining until the heat pump enters defrosting mode. For the defrosting to start, the temperature in the heat pump's evaporator must be low enough.

Current A **9.8**

Shows the current across the compressor.

Software HP PCB **20220518**

Shows the heat pump software version.

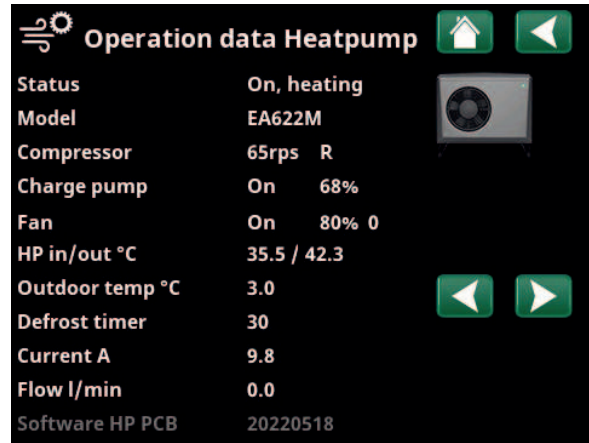

Menu: "Operation data, Heat pump".

Heat pump status	
On	The heat pump is in the "On" position.
On, DHW	The heat pump heats the DHW tank.
On, cooling	The heat pump is producing cooling for the heating circuit
On, heating	The heat pump is producing heat for the heating circuit.
Start delay: 1 min.	Compressor off - prevented from starting due to 1 min. start delay.
Off	Heat pump not charging the tank - no need.
Blocked in menu	Compressor Blocked in the "Installer/Settings/Heat Pump" menu.
Communication error HP	Control unit not communicating with heat pump.
Off, start ready	Compressor off but ready to start.
Driver block under voltage	Driver operating voltage too low.
Defrost	Defrosting in progress - air-to-water heat pump only.
Stop, low outdoor temp	Outdoor temperature lower than minimum limit - air-to-water heat pump only.
Off, alarm	Compressor off - alarm activated.
Stop, tariff	Compressor blocked due to active remote control function.
Blocked, low brine in °C	Incoming brine temperature too low, compressor blocked.
Flow on	Flow in the charging coil.



14.8.4 Operation data, Heat pump (brine-to-water)

Status **On, heating**

Heat pump status, see table below.

Model **EcoPart 410**

Shows model of selected heat pump.

Compressor **65RPS R (On/Off/RPS)**

Shows whether the compressor is operating or not. Displays the compressor speed for speed-controlled heat pumps. "R" stands for "Reduced Mode".

Charge pump **On 50%**

Shows operating status of the charge pump ("On" or "Off") and the flow in percent (0-100).

Brine pump **On 78%**

Shows operating status of the brine pump ("On" or "Off") and the speed in percent.

HP in/out °C **35.5 / 42.3**

Shows the heat pump's incoming and outgoing temperatures.

Brine in/out °C **2.0 / -1.0**

Shows the heat pump's return and primary flow brine temperatures.

AC Choke °C* **45.0**

Shows the temperature of the heat pump AC choke.

Inverter °C* **42.8**

Shows the inverter temperature.

Current A **0.0**

Shows the current across the compressor.

Software HP PCB **20200601**

Shows the heat pump software version.

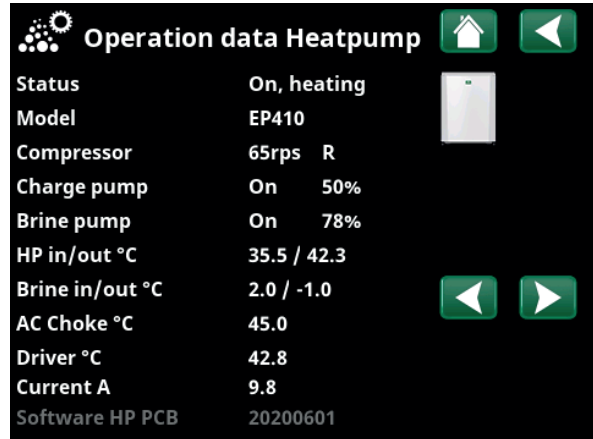

The menu shows detailed operation data of the selected heat pump.

**Only applies to inverter heat pump.*

Heat pump status	
On, DHW	The heat pump heats the DHW tank.
On, heating	The heat pump is producing heat for the heating circuit.
Start delay: 1 min.	Compressor off - prevented from starting due to 1 min. start delay.
Off	Heat pump not charging the tank - no need.
Blocked in menu	Compressor Blocked in the "Installer/Settings/Heat Pump" menu.
Communication error HP	Control unit not communicating with heat pump.
Off, start ready	Compressor off but ready to start.
Driver block under voltage	Driver operating voltage too low.
Off, alarm	Compressor off – alarm activated.
Stop, tariff	Compressor blocked due to active remote control function.
Blocked, low brine in °C	Incoming brine temperature too low, compressor blocked.
Flow on	Flow in the charging coil.



14.8.5 Stored Operation data

This menu shows cumulative operation values.

The operation values shown in the menu screenshots are only examples. The historical operational info presented varies depending on the language choice.

Total operation time h **3500**

Shows the total time the product has been powered.

Max primary flow °C **51**

Shows the highest temperature that has been supplied to the heating circuit.

Energy el. total (kWh) **250**

Shows how much additional heat has been used.

Compressor

Operation time /24 h:m **07:26**

Shows total operating time during the last 24 hours.

Total operation time **1500**

Displays total compressor operating time in hours.

Stored oper. data	
Total operation time h	3500
Max primary flow °C	51
Energy el. total (kWh)	250
Compressor	
Operation time /24 h:m	07:26
Total operation time	1500

Menu: "Operation data/Stored operation data".



14.8.6 Operation data, DHW

Mode	Comfort
Shows the active DHW program.	
DHW tank °C	45, 55 (55)
Shows the current temperature in the DHW tank and the setpoint (in brackets) for heat pump operation and during additional heat.	
DHW °C	45 (50)
Displays the DHW temperature and setpoint (in brackets).	
Capacity	50%
Displays the estimated amount of energy remaining for DHW.	
Extra DHW	On
"On" means the "Extra DHW" function is active.	
DHW circulation	Off
"On" means the "DHW circulation" function is active.	
SmartGrid	Off
The status of the SmartGrid functions for DHW is shown here.	

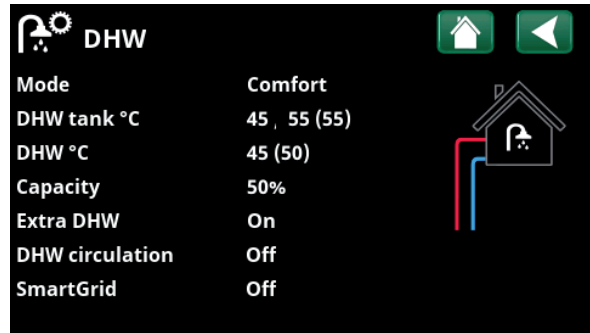

"Operation Data/DHW" menu.



14.8.7 Operation data, Diff thermostat function

This menu is displayed if a wood boiler has been defined in the "Installer/Define/Diff Thermostat Function" menu.

Status	On
Shows whether the charge pump is turned on ("On"/"Off").	
Temperature °C	51
Temperature in tank from which it is charged.	
Target temp. °C	43
Temperature in tank that it is charged to .	

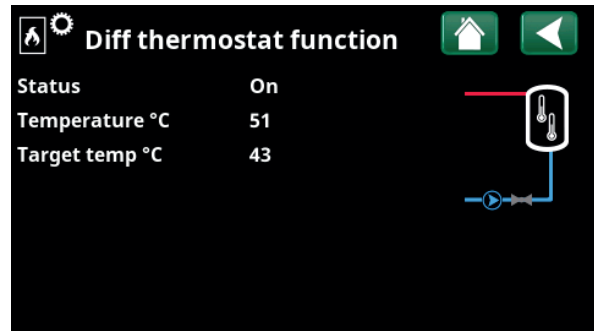

Menu: "Operation Data/Diff. thermostat function".



14.8.8 Operation Data, External heat source (EHS)

This menu is displayed if an External Heat Source has been defined in the "Installer/Define/External Heat Source (EHS)" menu.

System status DHW

Shows the various operational statuses of the system. Refer to the "Operation info/Control Unit" section.

Status On

The status of the external heat source can be "Off" or "On".

Temperature °C 47

Shows the current temperature in the EHS tank.

Charge start degrees 50

This is the minimum temperature required in the external heat source tank for the mixing valve to open and provide heat to the system.

SmartGrid Block. cap. Off

External heat source is blocked by SmartGrid due to "Overcapacity".

Mixing valve Closes

Indicates whether the EHS tank mixing valve increases (opens) or reduces (closes).

Demand DHW Yes (55)

"Yes" means that there is a need for hot water and that hot water is taken from the EHS tank. The DHW setpoint is shown in brackets.

Demand HC No (0)

"Yes" means that there is a need for heat in the heating circuit and that heat is taken from the EHS tank. The heating circuit setpoint is shown in brackets.

Demand pool No (0)

"Yes" means that there is a need for heat in the pool and that heat is taken from the EHS tank. The pool setpoint is shown in brackets.

The screenshot shows a dark-themed interface for the 'External heat source' menu. At the top, there is a home icon and a back arrow icon. Below the title, a list of parameters is displayed:

- System status: DHW
- Status: On
- Temperature °C: 47
- Charge start degrees: 50
- SmartGrid Blocking cap: Off
- Mixing valve: Close
- Demand DHW: Yes (55)
- Demand HC: No (0)
- Demand pool: No (0)

To the right of the text is a small schematic diagram of a mixing valve with a thermometer icon, showing red and blue lines representing hot and cold water paths.

Menu: "Operation Data/External Heat Source".



14.8.9 Operation data, External Boiler

System status DHW

Shows the various operational statuses of the system. Refer to the "Operation info/Control Unit/Status" section.

Status Standby

The external boiler may have the following status: "Off", "Standby", "Passive" or "Active".

Temperature °C 43

Shows current temperature of the boiler.

Boiler start out temp. 0

Shows the set outdoor temperature value (menu "Installer/Settings/External boiler") when the boiler is active.

Boiler, open mix.valve °C 70

This is the minimum boiler temperature required for the mixing valve to open and provide heat to the system.

Tariff ext. boiler Off

"On" means that the function is activated via remote control or a schedule.

Read more in the "Installer/Define/Remote Control" chapter.

SmartGrid Off

Boiler is blocked by SmartGrid due to "Overcapacity".

Mixing valve Closes

Indicates whether the boiler mixing valve increases (opens) or reduces (closes).

Demand DHW No (55)

"Yes" means that there is a need for hot water and that hot water is taken from the boiler. The DHW setpoint is shown in brackets.

Demand HC No (0)

"Yes" means that there is a need for heat in the heating circuit and that heat is taken from the boiler. The heating circuit setpoint is shown in brackets.

Demand pool No (0)

"Yes" means that there is a need for heat in the pool and that heat is taken from the boiler. The pool setpoint is shown in brackets.

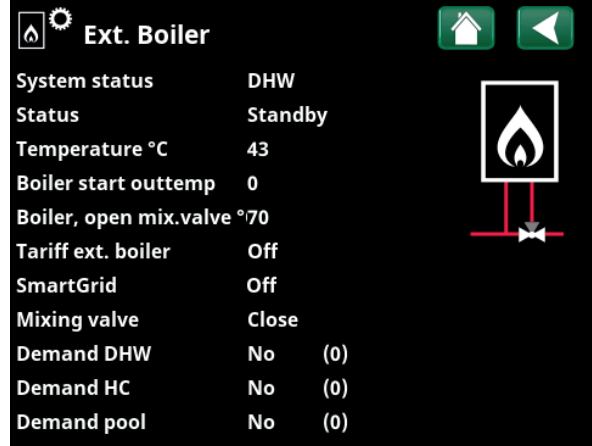

Menu "Operation Data/External boiler".



14.8.10 Operation data, El.prices

This menu is displayed if "El.prices" has been defined in the "Installer/Define/Communication" menu.

El.price mode **High**

Indicates the current price category ("High", "Medium" or "Low").

El.price/kWh **SEK 7.5**

Indicates the current electricity price in local currency.

Display the "Preview data" graph by clicking the "Graph icon" at the bottom-left of the menu screen.

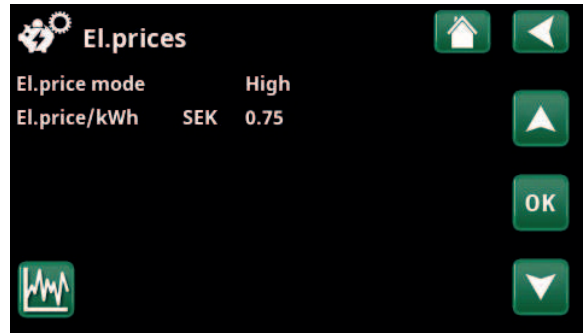

Menu: "Operation/El.prices".

For more information and examples of Smart Electricity Price Control/SmartGrid, see the website www.ctc-heating.com/Products/Download.



14.8.11 External signal

The menu shows the functions that are active via external control. The functions can be activated with:

- myUplink
- Virtuell digital in
- Modbus
- Relay
- SmartControl sensors

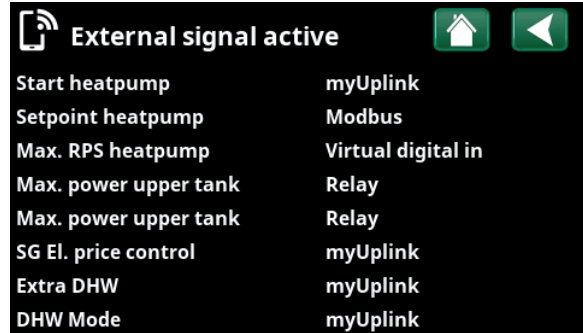

Menu: "Operation/External signal active".



Installer

This menu contains four sub-menus:

- Display
- Settings
- Define
- Service



For "System Information", click the "i" button in the lower right corner of the screen in the "Installer" menu. This displays the product serial number, MAC address, and application and bootloader versions. Click "Legal Information" to view information regarding third-party licences.

Scan the QR code with a tablet or smartphone. When your phone/tablet is connected to your local network, the product can be used with your device's touchscreen in the same way as the product's screen.

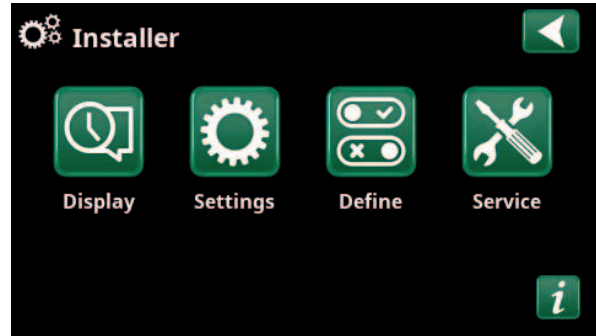

Menu: "Installer".

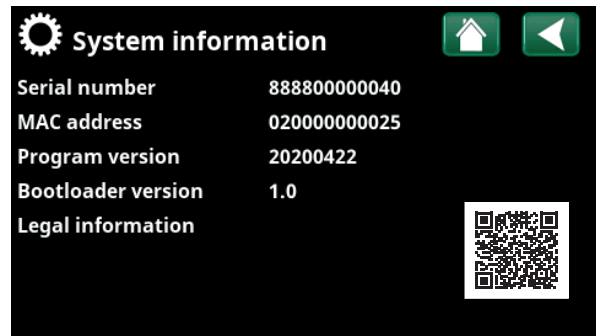

Menu: "Installer/System information". To access this menu, click the "i" button in the lower right corner of the "Installer" menu.



14.9 Display

Time, language and other screen settings can be carried out from this menu.



14.9.1 Setting the time

Time and Date

Click on the time symbol. The menu can also be accessed by clicking the date or time in the upper right corner of the start screen.

Press "OK" to highlight the first value and use the arrows to set the time and date.

DST (On, Active)

The left value can be set. "On" means the time is adjusted according to Summer Time.

The right value is fixed and shows the current status (for example, "Off" during the winter period). The display does not need to be connected to power for the values to be adjusted, since this occurs at the next start-up.

SNTP

Menu option "On" retrieves the current time from the internet (if online). More settings options can be found in the "Installer/Settings/Communication/Internet" menu.

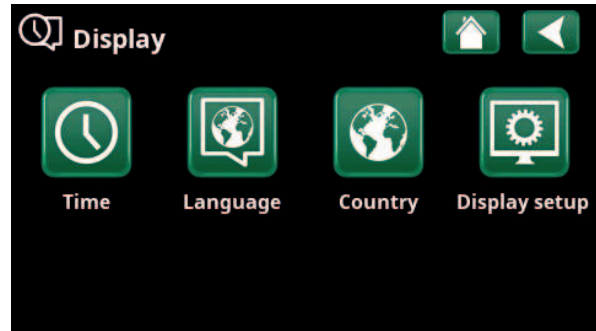

Menu: "Installer/Display".

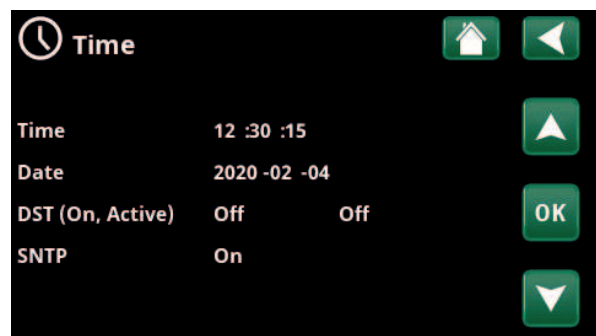

Menu: "Installer/Display/Time".



14.9.2 Language

Click a flag to select the language. The language selected is highlighted with a green square. To view more language options than those shown in the menu, scroll down the page, or press the down arrow key.



14.9.3 Country

Click on the "Country" symbol in the "Installer/Display" menu to display selectable countries and regions. The country that is displayed (highlighted in green) depends on which language has been selected.

"English" is the default language setting, which means that "GB United Kingdom of Great Britain and Northern Ireland" is the default country setting.

Select the country where the plant is installed to get correct spot prices. Depending on which country is selected, product-specific factory settings may vary.

"Country" must also be selected to receive correct electricity prices when controlling electricity prices via the myUplink mobile app.



14.9.4 Display setup

Sleep delay 120 (Off, 1...360)

Enter the time in minutes before the display enters sleep mode if not touched. Settings can be applied in 10 min. intervals.

Backlight 80% (10...90)

Set the brightness of the backlit display.

Click sound Yes (Yes/No)

Enable or disable button sounds.

Alarm sound Yes (Yes/No)

Enable or disable alarm sounds.

Time zone, GMT +/- +1 (-12...14)

Set your time zone (relative to GMT).

Lock code 0000

Press "OK" and use the arrows to set a 4-digit lock code. If a lock code is set, it is shown as four stars. You will be prompted to enter the code when the screen is restarted.

NB: Make a note of the lock code for your own reference when you enter it in the menu for the first time.

The serial number of the display (12 digits) can also be entered to unlock the display (enter '0000' + serial number); see chapter "Installer/System Information".

The display can be locked by clicking the product name in the upper left of the start menu, whereupon you will be prompted to enter the lock code.

A lock code can be deleted by entering "0000" in this menu instead of the previously specified lock code.

Font size Standard (Small/Standard/Large)

The display's font size can be changed here.

Selection colour 0 (0/1/2)

Option to change the cursor background colour for clearer selection according to the light conditions.

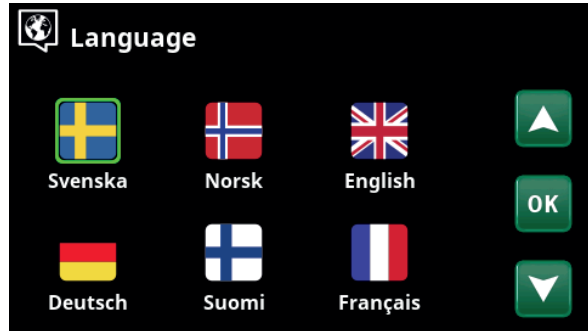

Menu: "Installer/Display/Language".



Menu: "Installer/Display/Country".

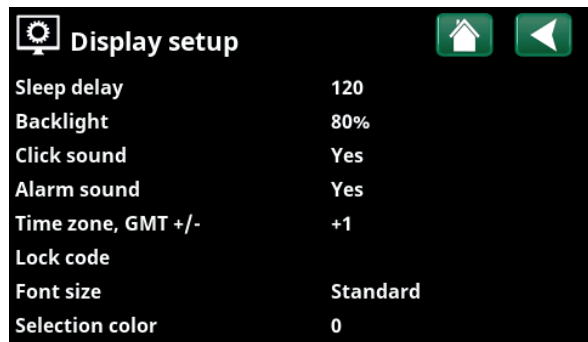

Menu: "Installer/Display/Display Setup".



14.10 Settings

This is used to set the parameters for your home's heating requirements. It is important that this basic setting is right for your home. Values which are set incorrectly may mean that your property is not warm enough or that an unnecessarily large amount of energy is being used to heat your property.

i First define the desired functions, see "Installer/Define". Settings are only displayed for enabled functions.

14.10.1 Settings Heating circuit*

In the "Settings" menu, select "Heating circuit" and then the heating circuit to be set.

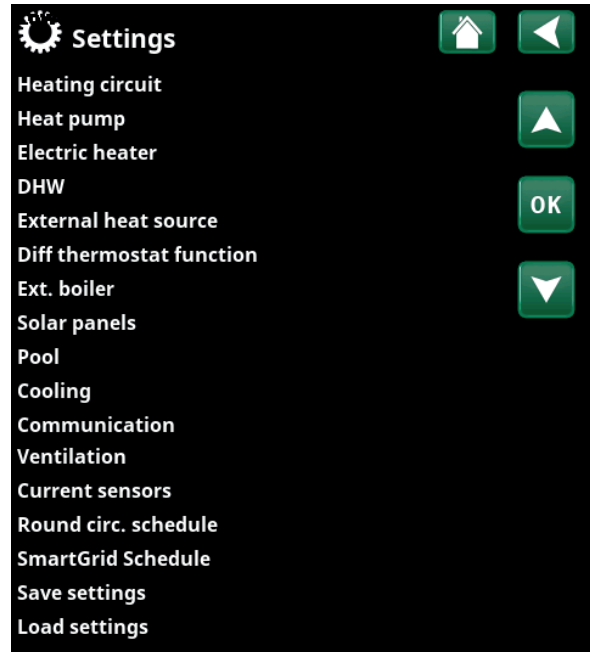

Menu: "Installer/Settings".

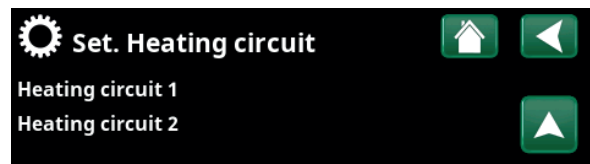

Part of the "Installer/Settings/Heating Circuit" menu.

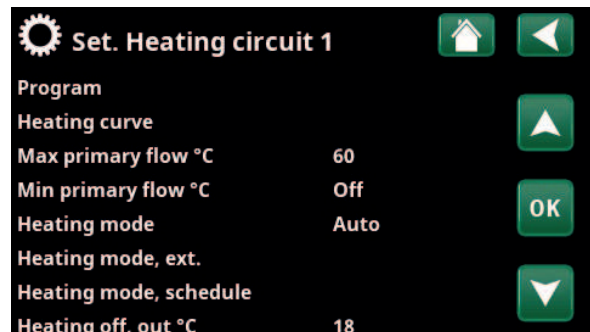

Part of the "Installer/Settings/Heating Circuit/Heating Circuit 1" menu.

*The heat pump can control up to two heating circuits.

Program

Press "OK" on the "Program" menu bar to make settings for the "Economy", "Comfort" and "Custom" heating programs. Selected programme is marked with an "X".

To activate a heating program or set a schedule, press the "Program" button from the "Heating/Cooling" menu. See chapter "Control system / heating/cooling".

• Primary flow change °C **-5 (-20...-1)**

The menu bar is displayed if the room sensor is not defined for the heating circuit. Setting "-5" (factory value program "Economy") means that the setpoint of the primary flow is lowered by 5 °C when the program is active.

• Room temp change °C **-2.0 (-5.0...-0.1)**

The menu bar is displayed if the room sensor is defined for the heating circuit. Setting "-2" (factory value program "Economy") means that the setpoint for room temperature is lowered by 2 °C when the program is active.

• Off delay, min **No (No/10...600)**

Off delay means the time in minutes after the heating program "Economy", "Comfort" or "Custom" has been activated as the heating mode returns to the program "Normal". However, if the "Custom" program is selected later than the "Normal" program, the "Custom" program will apply after the Off delay. The Off delay is adjusted in steps of 10 minutes for each key press (up or down arrow).

"No" means that the selected program will be activated until another heating program is activated.

• SmartGrid Blocking* **Off (Off/On)**

The menu bar is displayed when setting the heating programme "Economy" or "Custom".

"On" means that the heating program is activated when "SmartGrid Blocking" is active.

SmartGrid Low price* **Off (Off/On)**

The menu bar is displayed when setting the heating programme "Comfort" or "Custom".

"On" means that the room temperature is increased according to the setting for "SmartGrid Low price °C" when "SmartGrid Low price" is active.

SmartGrid Overcapacity* **Off (Off/On)**

The menu bar is displayed when setting the heating programme "Comfort" or "Custom".

"On" means that the room temperature is increased according to the setting for "SmartGrid Overcapacity °C" when "SmartGrid Overcapacity" is active.

• Reset program

Current program is reset with factory values.

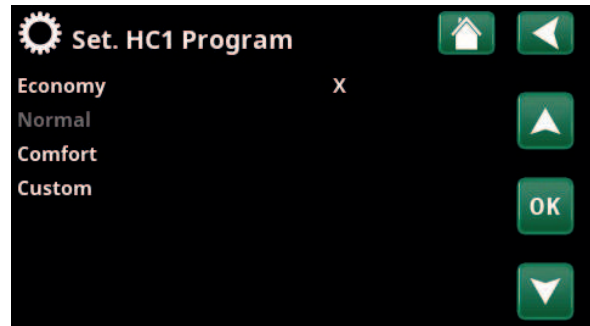

Menu "Installer/Settings/Heating Circuit/Heating Circuit 1/Program".

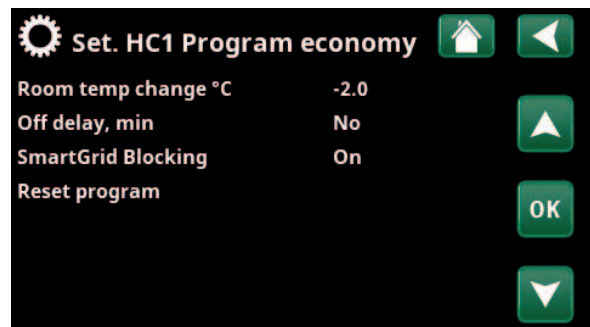

Menu "Installer/Settings/Heating Circuit/Heating Circuit 1/Program/Economy".

*SmartGrid functions are set in the menu "Installer/Settings/Heating circuit".

Heating curve

The heating curve determines the primary flow temperature (and thus the indoor temperature) to the heating circuit at different outdoor temperatures.

See chapter "Your home's heating installation" for more information on adjusting the heating curve.

Possible choices are "Set. heating curve", "Fine adjustment", "Active curve", "Copy from ..." and "Reset curve".

• Set. heating curve

The thicker line shows the factory-set curve while the thinner line shows the active heating curve to be reset. Here it is possible to adjust the appearance of the graph by adjusting the curve inclination and curve adjustment with the buttons below the graph. The adjustments you make here affect the entire appearance of the graph, while the changes made under "Fine adjustment" are made one point at a time. Curve inclination is adjusted with the left and right arrows while curve adjustment is adjusted with the up and down arrows. Confirm with "OK".

• Fine adjustment

The graph of the active heating curve for the heating circuit is displayed. The heating curve can be adjusted in 5 points on the graph. Touch a point (becomes green) to change its position in the x-axis (outdoor temperature) and y-axis (primary flow temperature). Use the up/down/left/right buttons below the graph or press and drag the point.

Below the graph, the outdoor and primary flow temperatures for the selected point are shown. The heating curve can also be adjusted from the "Heating/Cooling" menu. See chapter "Control system / heating/cooling".

• Active curve 1 (1/2)

This menu bar shows the selected heating curve, it is possible to choose between two different heating curves per heating circuit.

• Copy from 1 (2)

The function "Copy from ..." is useful if you have created two different heating curve graphs but want to restore one graph to the same appearance as the other and then make changes.

Example: If heating curve 1 is selected as "Active curve", heating curve 1 will have the same appearance as heating curve 2 by selecting the line "Copy from 2" and pressing "OK". The menu bar cannot be selected (marked with gray) when heating curves 1 and 2 have the same values (the graphs look the same).

• Reset curve

Resets the active heating curve to the factory-set curve.

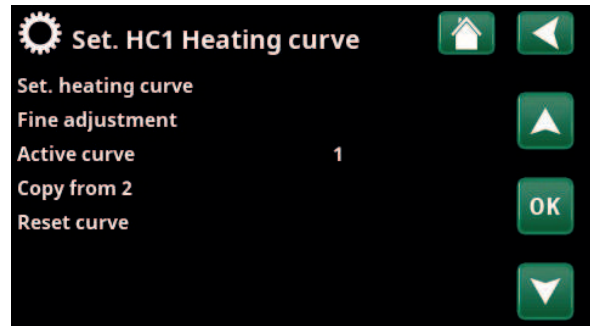

Menu "Installer/Settings/Heating Circuit/Heating Circuit 1/Heating curve".

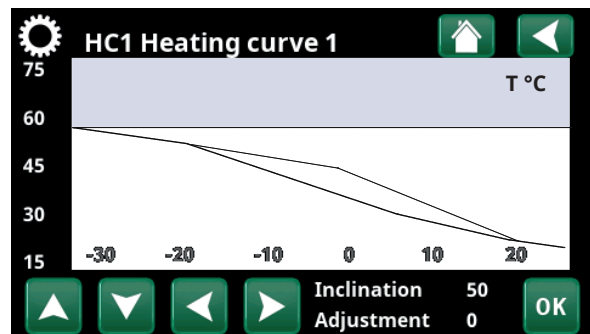

Menu "Installer/Settings/Heating Circuit/Heating Circuit 1/Heating curve".

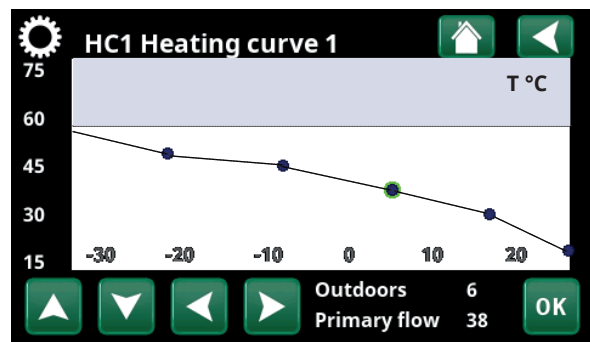

Menu "Installer/Settings/Heating Circuit/Heating Circuit 1/Heating curve/Fine adjustment".

Max primary flow °C 60 (30...70)

Maximum permitted temperature supplied to the respective heating circuit.

Min primary flow °C Off (Off/15...65)

Minimum permitted temperature supplied to the respective heating circuit.

Heating mode Auto (Auto/On/Off)

Switching between heating season and summer mode can take place automatically (Auto) or a selection can be made here to set the heating to "On" or "Off".

Heating mode can also be selected from the start page by pressing the "Mode" button in the Heating/Cooling menu.

- **Auto** = switching the heating season On and Off carried out automatically.
- **On** = Continuous heating season, the radiator pump circulates constantly.
- **Off** = there is no heating, the radiator pump does not run (is turned over).

Heating mode, ext. - (Auto/On/Off)

The heating mode selected in this menu can be enabled/disabled externally.

This menu bar is displayed for the current heating circuit if a remote control input or a schedule has been defined for the function.

Read more in the "Def. Remote Control" section of the "Installer/Define" chapter.

Heating mode, schedule

This menu bar is displayed if a schedule has been defined for the "HC Heating mode, ext." function in the remote control menu.

For more information, refer to:

- chapter "Schedule".
- section "Def. Remote Control" of the "Installer/Define" chapter for defining the remote control function.

Heating off, out °C 18 (2...30)

Heating off, time (min) 120 (30...1440)

Heating on, time (min) 120 (30...1440)

The menu bars can only be set if the "Auto" mode is selected in the "Heating mode" menu above. Otherwise, the menu bars are locked (greyed out).

When the outdoor temperature exceeds (or equals) the set value in the "Heating off, out °C" menu during the time (in minutes) set in the "Heating off, time (min)" menu, the production of heat for the house is stopped.

This means the radiator pump stops, and the mixing valve remains closed. The radiator pump is activated daily for a short period to prevent it from jamming. The system restarts automatically when heating is needed.

When the outdoor temperature drops to the limit where heating is needed again, heat to the house is permitted when the temperature falls below (or equals) the set value in the "Heating off, out °C" menu for the number of minutes set in the "Heating on, time (min)" menu.

Menu "Installer/Settings/Heating Circuit/Heating Circuit 1".

Night reduction down to °C **5 (-40...40)**

When the outdoor temperature is lower than this, the "Night Reduction" function stops since too much energy is consumed and it takes too long to increase the temperature again.

This menu overrides remote control of "Night Reduction".

Room temp. reduced, Night red °C **-2 (0...-40)****Room temp. reduced, Holiday °C** **-2 (0...-40)**

The menus are displayed if room sensors are installed for the heating circuit. The number of degrees by which the room temperature should be lowered during remote-controlled night reduction and during holidays can be set here. Night reduction can also be set periodically; the temperature decrease is then entered in the schedule.

Prim. flow reduced, Night red °C **-3 (0...-40)****Prim. flow reduced, Holiday °C** **-3 (0...-40)**

The menus are displayed if room sensors are not installed for the heating circuit. The number of degrees by which the primary flow temperature for the heating circuit should be lowered during remote-controlled night reduction and during holidays can be set here. Night reduction can also be set periodically; the temperature decrease is then entered in the schedule.

Alarm room temp °C **5 (-40...40)**

If the room temperature is too low (according to the set value), the message "Alarm, low room temp." will be displayed.

This menu bar is displayed if the room sensor is connected and defined.

SmartGrid Low Price °C **1 (Off/1...5)**

Setting to increase the room temperature at "Low price" energy price, via SmartGrid.

Both SmartGrid A and SmartGrid B must be defined in the remote control menu for this menu to be displayed.

Read more in the "Remote Control/SmartGrid A/B" section of the "Installer/Define" chapter.

SmartGrid Overcapacity °C **2 (Off/1...5)**

Setting to increase the room temperature at "Overcapacity" energy price, via SmartGrid. This function is not used for electricity price control.

Both SmartGrid A and SmartGrid B must be defined with a remote control input for this menu to be displayed.

Read more in the "Remote Control/SmartGrid A/B" section of the "Installer /Define" chapter.

SmartGrid Blocking **Off (Off/On)**

"On" means the heating circuit is blocked at "High" energy price, via SmartGrid. If the outdoor temperature falls below the value set in the "Night reduction down to °C" menu, this function is not activated.

Both SmartGrid A and SmartGrid B must be defined with a remote control input for this menu to be displayed.

Read more in the "Remote Control/SmartGrid A/B" section of the "Installer /Define" chapter.

● If room sensors are installed, the "Room temp reduced..." menu is displayed. If there are no room sensors, the "Primary flow reduced..." menu is displayed.

Example

As a rule, a "Primary flow reduced" reduced value of 3 to 4 °C is equivalent to a reduction of approximately 1 °C in room temperature in a normal system.

Max time heating (min) 20 (10-120)

This is the maximum time (minutes) during which the heat pump charges the heating circuit if needed in the hot water tank.

Charge pump % 60 (20-100)

Setting for charge pump (G11) speed (percent) when charging the heating circuit.

Drying period mode Off (Off/1/2/3)

Applies to Heating circuit 1. Drying period for newly built properties. The function limits the calculation of primary flow temperature (setpoint) for "Your home's heating settings" to the schedule below.

Mode 1 - Drying period for 8 days

1. The setpoint of the radiator system is set to 25 °C for 4 days.
 2. On Days 5-8, the set value in "Drying period temperature °C" is used.
- (From Day 9 onwards the value is calculated automatically according to "Your home's heating settings").

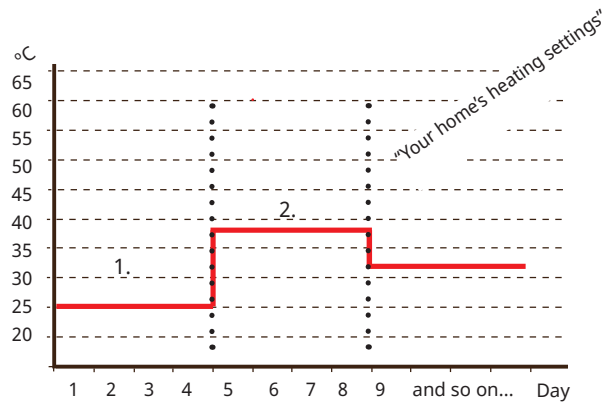

Example: Mode 1 with set value "Drying period temp °C": 38.

Mode 2 - Drying period for 10 days + stepped increased and decrease

1. Stepped increase start: The setpoint of the radiator system is set to 25 °C. The setpoint is then raised by 5 °C each day until it is equal to the "Drying period temp °C". The final step may be less than 5 °C.
 2. Drying period for 10 days.
 3. Stepped decrease: After the stepped increase and 10 days at an even temperature, the temperature setpoint is reduced to 25 °C in daily 5 °C stages.
- The final step may be less than 5 °C.

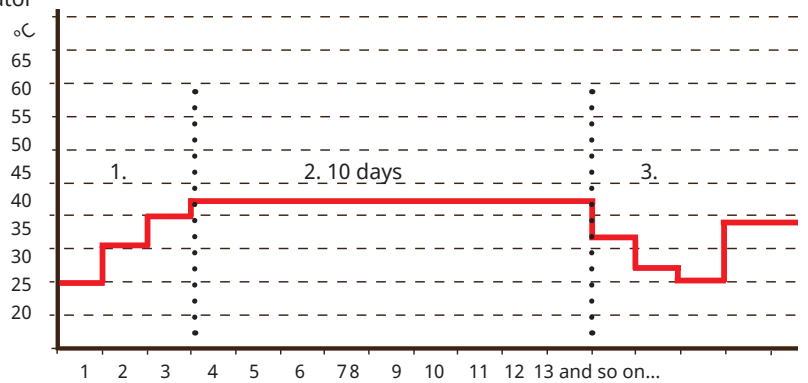

Example: Mode 2 with set value for "Drying period temp °C": 37.

Mode 3

In this mode, the function starts in "Mode 1" followed by "Mode 2" and lastly by "Your home's heating settings".

Drying period temp °C 25 (25...55)

The temperature for "Mode 1/2/3" as shown above is set here.

Drying period mode Off (Off/On)

This menu bar is displayed for Heating Circuit 2 if a heating mode (1-3) is selected in the "Drying period mode" menu above.

The "On" option means that the drying period mode selected for Heating Circuit 1 will also be run for the selected heating circuit.

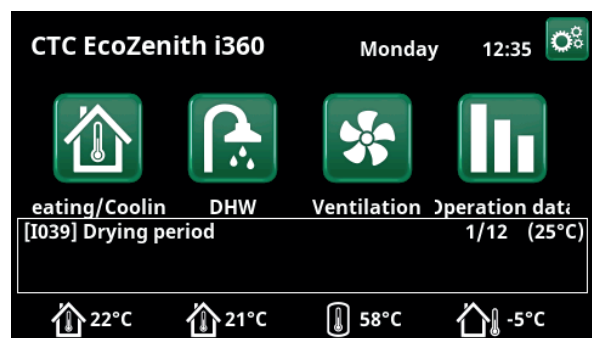

Example: Drying period temperature day 1 of 12 with current set point of 25 °C.

14.10.2 Settings Heat pump

Compressor **Blocked (Permitted/Blocked)**

The heat pump is supplied with a blocked compressor. "Permitted" means that the compressor can start.

Brine pump **Auto (Auto/10 days/On)**

After installation is complete, you can choose to run the brine pump constantly for 10 days to remove air from the system. The brine pump then enters "Auto" mode. "On" means the brine pump runs constantly.

Only applies to brine-to-water heat pumps.

Stop at outdoor temp °C **-22 (-22...10)**

This menu relates to settings for the outdoor temperature at which the compressor is no longer permitted to operate. The heat pump starts 2°C above the set value.

Only applies to air-to-water heat pumps.

Compressor stop at brine °C **-5 (-15...10)**

This menu defines the brine temperature at which the compressor will be stopped.

Only applies to brine-to-water heat pumps.

Tariff HP **No (No/Yes)**

"Yes" means the function can be activated via remote control.

Read more in the "Def. Remote Control" section of the "Installer/Define" chapter.

Tariff HP schedule

This menu bar is displayed if a schedule has been defined for the "HP Tariff" function.

For more information, refer to:

- chapter "Schedule".
- section "Def. Remote Control" of the "Installer/Define" chapter for defining the remote control function.

SmartGrid Block. HP **No (No/Yes)**

"Yes" means that the heat pump is blocked when "SmartGrid Blocking" is active.

Read more in the "Remote Control /SmartGrid" section of the "Installer/Define" chapter.

Start at degree minute **-60 (-900...-30)**

Start at degree minute cooling **60 (30...900)**

This specifies the degree minute at which the heat pump should start for heating respectively cooling demand.

HS<->DHW time (sec) **120 (30...240)**

Time in seconds for which the compressor maintains a constant speed while switching between heating and hot water.

Max RPS **100* (50...120)**

The maximum permissible speed of the compressor at "winter temperature". Sets the compressor's maximum speed (R2) at outdoor temperature T2.

Only applies to modulating air-to-water heat pumps.

The screenshot shows the 'Set. Heat pump' menu with the following settings:

- Compressor: Blocked
- Brine pump: Auto
- Stop at outdoor °C: -22
- Compressor stop at brine°C: -5
- Tariff HP: No
- Tariff HP schedule: No
- SmartGrid Block. HP: No
- Start at degree minute: -60
- Start at degree minute cooling: 60
- HC<->DHW time (sec.): 120
- Max RPS: 100
- Max RPS warm temp: 50
- Ext. noise reduction RPS: 50
- Noise reduction schedule: No
- Cold temp limit: 0
- Warm temp limit: 20
- Passive cooling brine pump on: On
- Silent mode, schedule: No
- Defrost Heating coil Temp Min m10: No
- Defrost Heating coil Temp Max n10: No
- Defrost Heating coil Temp Min °C10: No
- Defrost Heating coil Temp Max °f-10: No

Menu: "Installer/Settings/Heat pump".

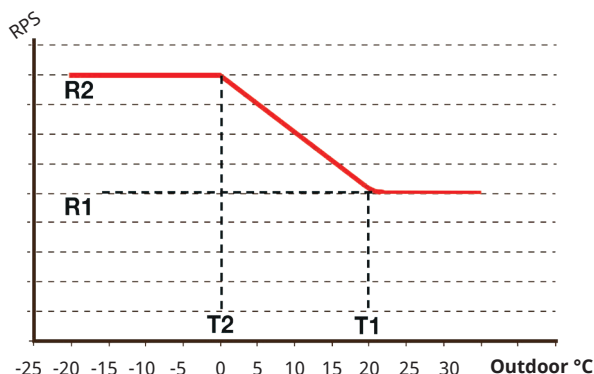

The diagram shows that the compressor speed is controlled according to the outdoor temperature.

When the outdoor temperature is below T2, the compressor speed adjusts up to R2.

When the outdoor temperature exceeds T1, the compressor speed adjusts down to R1.

These temperature and speed limits are set in the menus on the left.

Max RPS warm temp **50 (50...100)**

The maximum permissible speed of the compressor at "summer temperature". Sets the compressor's maximum speed (R1) at outdoor temperature T1.

Only applies to modulating air-to-water heat pumps.

Ext. noise reduction RPS **50 (20...-120)**

Set the compressor speed value applicable for remote control.

Read more in the "Def. Remote Control" section of the "Installer/Define" chapter.

Noise reduction schedule

This menu starts a schedule with limited compressor speed to reduce the noise level.

The "Schedule" chapter describes how to set schedules.

Cold temp limit **0 (0...-15)**

When the outdoor temperature is equal or lower (T2), the compressor speed is adjusted up to speed R2.

Warm temp limit **20 (0...20)**

When the outdoor temperature is equal or higher (T1), the compressor speed is adjusted down to speed R1. The heat pump starts and stops at the actual value and setpoint value.

Only applies to modulating air-to-water heat pumps.

Passive cooling brine pump on **On (On/Off)**

Enable "Yes" if the brine pump should be used for passive cooling.

Only applies to brine-to-water heat pumps.

Silent mode, schedule

It is possible to start a schedule, e.g. during the night, with limited compressor speed and fan speed to reduce the noise level.

The "Schedule" chapter describes how to set schedules.

Only applies to CTC EcoAir 600M/700M.

Defrost heating temp min m **10 (0...360)**

Set the minimum heating time "Min m" (minutes) for the heating coil in the condensation tray at outdoor temperature T1.

Defrost heating temp max m **10 (0...360)**

Set the maximum heating time "Max m" (minutes) for the heating coil in the condensation tray at outdoor temperature T2.

Defrost heating temp min °C **10 (-40...40)**

When the outdoor temperature is this or higher (T1), the heating time is regulated down to the value set in the menu "Defrost heating temp min m".

Defrost heating temp max °C **-10 (-40...40)**

When the outdoor temperature is this or lower (T2), the heating time is regulated up to the value set in the menu "Defrost heating temp max m".

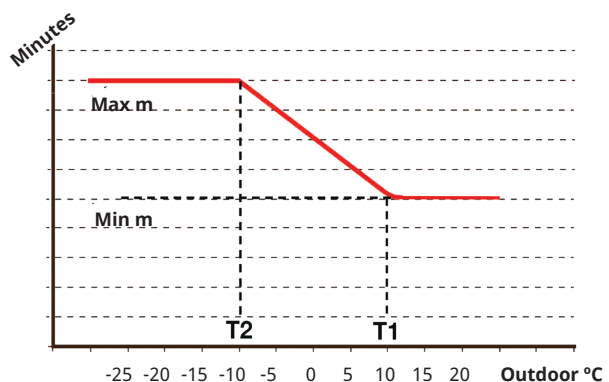

The diagram shows that the heating time of the heating coil to the condensation trays is regulated depending on the outside temperature.

When the outdoor temperature is below T2, the heating time adjusts up to "Max m".

When the outdoor temperature exceeds T2, the heating time adjusts down to "Min m".

These temperatures and times are set in the menus "Defrost heating temp..." on the left.

14.10.3 Settings Immersion heater

Max immersion heater kW 9.1 (0.0...9.1)

Here you select the power that the immersion heater is permitted to provide.

The setting range may vary depending on the heat pump model.

The setting range varies, see "Electrical data" in the chapter "Technical data". For language choices "German" and "French" the max electric power is factory set at 0.0 kW.

Max immersion heater DHW kW 9.1 (0.0...9.1)

Here you select the power that the lower immersion heaters are allowed to emit.

The setting range varies, see "Electrical data" in the chapter "Technical data". For "Country" Germany and France, the max electric power is factory set at 0.0 kW.

Start at degree minute -500 (-900...-30)

This menu is used to define at how many degree minutes the immersion heater should start.

Diff step, degree minute -50 (-300...-20)

This menu is used to define the difference in degree minutes between the start and stop conditions for the immersion heater. If the immersion heater is started at -500 degree minutes, it will be stopped at -450 degree minutes (for a setting of -50).

Main fuse A 20 (10...90)

The property's main fuse size is set here. This setting and the fitted current sensors ensure the fuses are protected when using appliances which generate temporary power peaks, for example, cookers, ovens, engine heaters, etc. The product temporarily reduces power drawn where this type of equipment is being used.

Conv. factor current sensor 1 (1...10)

This menu is used to specify the conversion factor the current sensor should use. This setting is only performed if the connection has been installed for a current sensor for higher currents.

Example: User (set) value 2 => 16 A will be 32 A.

Tariff EL No (Yes/No)

This menu bar is displayed if an "Input" for remote control is defined for the "Tariff EL" function in the "Installer/Define/Remote Control" menu.

"Yes" means the function can be activated via remote control.

Read more in the "Installer/Define/Remote Control/Tariff EL" chapter.

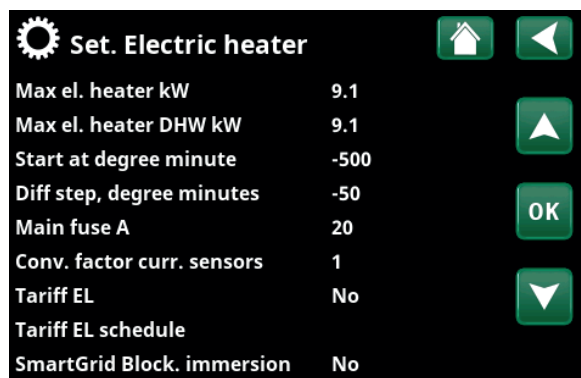

Menu: "Installer/Settings/Immersion heater".

Tariff EL schedule

This menu bar is displayed if a "Schedule" is defined for the "Tariff EL" function in the "Installer/Define/Remote Control" menu.

For more information, refer to:

- chapter "Schedule".
- section "Def. Remote Control" of the "Installer/Define" chapter for defining the remote control function.

SmartGrid Block. immersion No (Yes/No)

For this menu to be displayed, define a remote control input for both SmartGrid A and SmartGrid B.

"Yes" means that the additional heat is blocked when "SmartGrid Blocking" is active.

Read more in the "Installer/Define/Remote Control" chapter.

14.10.4 Settings DHW

The menus below are displayed if "DHW" has been defined in the "Installer/Define /DHW" menu. Sensor B5 measures the temperature in the DHW tank.

DHW program

Available options are "Economy", "Normal" and "Comfort".

Press "OK" to open the settings for the selected DHW program. The factory settings shown below apply to "Normal" mode. Refer to the "Parameter List" chapter for the "Economy" and "Comfort" modes' factory settings.

• Charge start% No (No/50...90)

Value Charge start: 60% indicates that the charging of hot water is allowed to start when the amount of hot water is estimated to be "60%" or less. "No" means that the estimated amount of hot water does not affect the start of the hot water charging.

• Charging stop upper/lower °C 55 (20...65)

Charging of the hot water is complete when both sensors have reached the set value.

• Charge start lower °C 40 (15...60)

Hot water charging starts when the temperature falls below the set temperature.

• DHW °C 50 (38...65)

The DHW out temp.

• Permitted add.heat, outdoor °C No (-40...40)

Additional heating is allowed for hot water charging when the outdoor temperature is equal to or below the set temperature.

"No" means that additional heating cannot be used regardless of the outdoor temperature.

• Reset program

The current DHW program will be reset to factory settings.

Start/stop diff. upper °C 5 (3...7)

This menu is used to set the negative hysteresis before the heat pump starts charging the DHW tank after the setpoint has been reached.

Example: If the stop temperature is 55 °C and hysteresis is set to 5 °C in this menu, it means the heat pump will start DHW charging again when the temperature in the tank has dropped to 50 °C.

Max time DHW (min) 30 (10...150)

This specifies the maximum time for which the heat pump heats the DHW tank.

Charge pump % 50 (20...100)

The charge pump speed is set here.

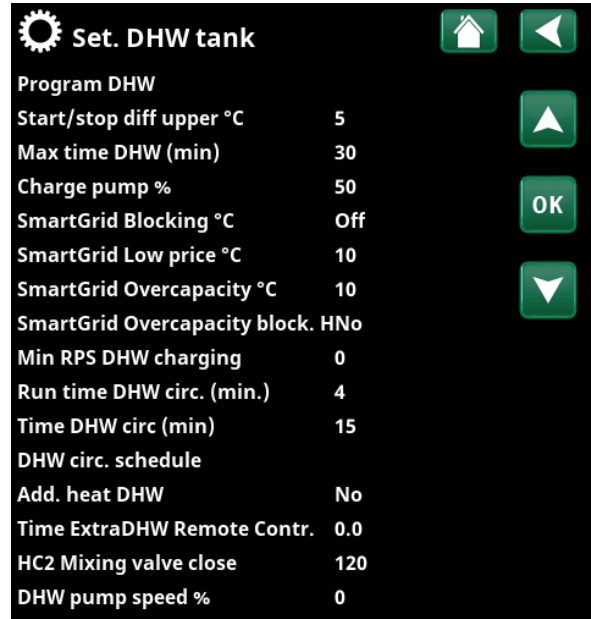

Menu: "Installer/Settings/DHW".

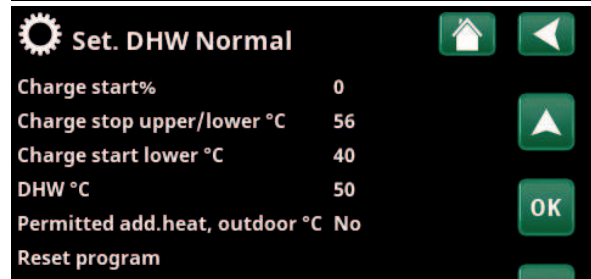
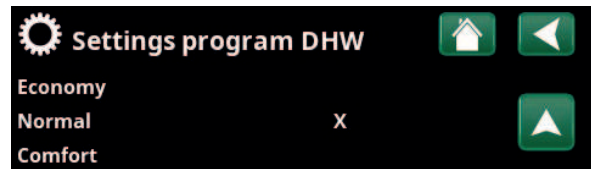

Menu: "Installer/Settings/DHW/DHW Program".

SmartGrid Blocking °C **Off (Off/-1...-50)**

The setpoint for DHW tank heating is decreased by the value set in this menu when "SmartGrid Blocking" is active.

Both SmartGrid A and SmartGrid B must be defined in the remote control menu for this menu to be displayed.

Read more in the "Def. Remote Control /SmartGrid A/B" section of the "Installer/Define" chapter.

SmartGrid Low price °C **Off (Off/1...30)**

The setpoint for DHW tank heating is increased by the value set in this menu when "SmartGrid Low price" is active.

Both SmartGrid A and SmartGrid B must be defined in the remote control menu for this menu to be displayed.

Read more in the "Def. Remote Control /SmartGrid A/B" section of the "Installer/Define" chapter.

SmartGrid Overcapacity °C **Off (Off/1...30)**

The setpoint for DHW tank heating is increased by the value set in this menu when "SmartGrid Overcapacity" is active.

Both SmartGrid A and SmartGrid B must be defined with a remote control input for this menu to be displayed.

Read more in the "Def. Remote Control /SmartGrid A/B" section of the "Installer/Define" chapter.

SmartGrid Overcapacity block HP **No (No/Yes)**

"Yes" means that DHW tank heating using the heat pump is blocked when "SmartGrid Overcapacity" is active.

Min RPS DHW charging **50 (50...100)**

Lowest compressor speed during hot water charging. When the heat pump switches from heating to hot water, this RPS is used for hot water.

Run time DHW circ. (min) **4 (1 to 90)**

The length of time that DHW circulation should active during each period. Displayed if "DHW circulation" has been defined in the "Installer/Define/DHW" menu.

Time DHW circ. (min) **15 (5...90)**

Time between periods of DHW circulation. Displayed if "DHW circulation" has been defined in the "Installer/Define/DHW" menu.

DHW circ. schedule

This menu displays the scheduled weekday periods when the DHW circulation pump is to run. The menu bar is displayed if:

- "DHW circulation" has been defined in the "Installer/Define/DHW" menu.
- a "Schedule" is defined for the DHW Circulation" function in the "Installer/Define/Remote Control" menu.

For more information, refer to:

- chapter "Schedule".
- section "Def. Remote Control" of the "Installer/Define" chapter for defining the remote control function.

SmartGrid Blocking °C	Off
SmartGrid Low price °C	10
SmartGrid Overcapacity °C	10
SmartGrid Overcapacity block. HNo	
Min RPS DHW charging	0
Run time DHW circ. (min.)	4
Time DHW circ (min)	15
DHW circ. schedule	
Add. heat DHW	No
Time ExtraDHW Remote Contr.	0.0

Menu: "Installer/Settings/DHW".

Add. heat DHW**Auto (Yes/No/Auto)**

"No" means that no immersion heater or external boiler is used to produce hot water.

"Auto" means that hot water is produced primarily by a heat pump. When the charging time is exceeded and the stop temperature is not reached by the heat pump, additional heating will be allowed during the next hot water heating cycle.

"Yes" means that an immersion heater or external boiler may be used to produce hot water.

See also "Immersion heater/Max. Immersion heater DHW kW" and "External boiler/Prio DHW tank".

Time ExtraDHW Remote Contr.**0.0 (0.0...10.0)**

The duration of time that extra DHW will be produced for the DHW tank is set here. The "Extra hot water" function is activated via remote control.

The menu bar is displayed if:

- a normal mode for the external control signal (Normally Open (NO)/Normally Closed (NC)) is defined for the function in the "Installer/Define/DHW Tank" menu.
- an "Input" for "Extra DHW" has been defined in the "Installer/Define/DHW tank" menu.

HC2 Mixing valve close**120 (Off/1...300)**

The time in seconds to position the mixing valve at 50%. This is done to prevent flow problems when charging DHW.

This menu is displayed if heating circuit 2 is defined.

14.10.5 Settings External heat source (EHS)

Charge start °C 70

This is the minimum temperature required in the external heat source tank (B47) for the mixing valve to open and emit heat to the system.

Stop diff °C 5

Temperature difference before charging stops from the additional heating source.

SmartGrid Blocking cap. No (No/Yes)

Electric operation prioritised. The shunt on the EHS tank is closed to accumulate heat energy.

Read more in the "Installer/Define/Remote control/SmartGrid" menu.

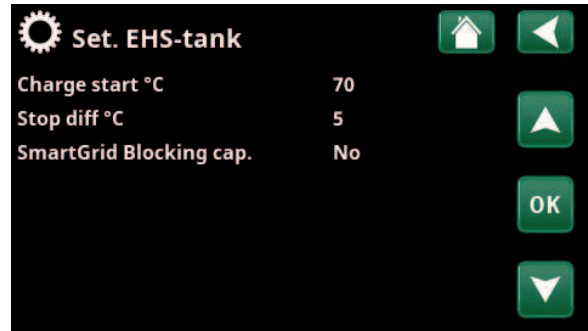

Menu: "Installer/Settings/External Heat Source".

14.10.6 Settings Diff thermostat function

The function must be defined before the settings can be entered. Diff thermostat function is used to charge the system tank from a different heat source.

Charge start diff temp °C 7 (3...30)

Here you can set the temperature difference determining when charging from the heat source is started. The heat source must be this many degrees warmer than the tank temperature for charging to start.

Charge stop diff temp °C 3 (2...20)

The temperature difference which determines when charging from the heat source is stopped is set here. When the temperature difference between the product and the tank falls below this set value, charging stops.

Charge temperature °C 60 (10...80)

The maximum permitted temperature in the lower tank is set here. The charging stops if this temperature is exceeded.

Charge tank No (No/Yes)

Overcharging from the heat pump's lower tank to the buffer tank starts when:

- Setting menu bar "Charge tank" = "Yes".
- "SmartGrid Low price" or "SmartGrid Overcap." is active and a temperature increase via SmartGrid is set in the lower tank.
- The heat pump charges the buffer tank and the temperature in the lower tank is 5 °C higher than the previous set point* and the temperature in the buffer tank is 5 °C lower than the previous set point*.

Overcharging to the buffer tank continues until:

- The heat pump stops charging the lower tank (the need to charge the tank has disappeared).
- The temperature in the lower tank has dropped to the setpoint.
- "SmartGrid Low Price/Overcap." is not active.

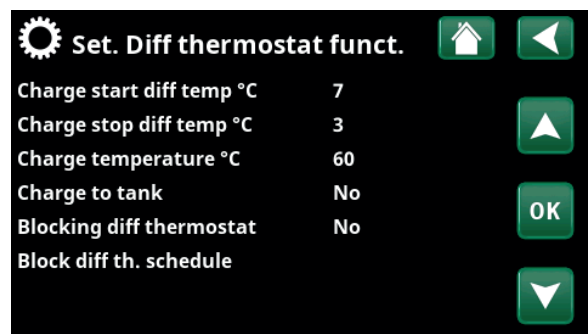

Menu: "Installer/Settings/Diff Thermostat Function".



Ensure a high flow on the pump (G46) so that a low temperature difference of approx. 5-10°C is achieved over the EHS tank during charging.

Block diff thermostat No (No/Yes)

"Yes" means the function can be activated via remote control.

Block diff th. schedule

Access function scheduling from the "Block diff th. schedule" row.

*Previous setpoint means the setpoint before "SmartGrid Low Price" or "SmartGrid Overcap." was activated.

14.10.7 Settings External Boiler

Ext. Boiler-Mode **Auto (Auto/On/Off)**

Mode for adjusting an external boiler.

- **Auto** = adjusted as needed according to selected settings.
- **On** = continuously active.
- **Off** = mode in which the external boiler does not start, e.g., because there is no heat source available.

Boiler start out temp. **0 (-30...30)**

External boiler started at this outdoor temperature through the powering of E1.

Delay stop ext. boiler **0 (0...1440)**

If an external boiler is no longer needed, shutting it off can be delayed. This is used to avoid operation times too short (risk of corrosion). The boiler is kept warm for the set time, 10 minutes at a time.

Boiler, open mix.valve °C **70 (20...90)**

This is the minimum temperature required in the external boiler tank (B9) for the mixing valve to open and emit heat to the system. Used to, e.g., avoid condensation in oil boiler.

Stop diff °C **5 (1...15)**

Temperature difference compared to desired tank temperature before the mixing valve is allowed to open.

Hysteresis for "Boiler, open mixing valve °C". When the mixing valve has opened, the temperature may fall by this amount before the mixing valve closes.

Start boiler, degree minute **-300 (-900...-30)**

For the shunt to open and emit heat to the system, this requires a loss of degree minutes, which is set here.

Stop boiler diff, degree minute **-50 (-300...-20)**

This menu is used to define the difference in degree minutes between the start and stop conditions for the external boiler. If the boiler is started at -300 degree minutes, it will be stopped at -200 degree minutes (for a setting of -100).

Priority DHW tank **Low (Low/High)**

Controls whether the external boiler is prioritised before electricity is added when producing hot water.

- **Low** – immersion heater activated before external boiler.
- **High** – external boiler activated before adding electricity.

SmartGrid Block. boiler **No (No/Yes)**

Controls whether the external boiler is blocked by settings in SmartGrid function.

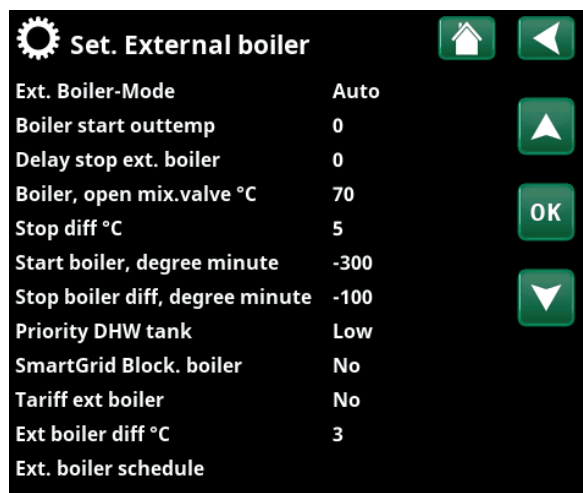

Menu "Installer/Settings/External Boiler".

Tariff ext. boiler **No (Yes/No)**

This menu bar is displayed if an "Input" for remote control is defined for the "Tariff EL" function in the "Installer/Define/Remote Control" menu.

"Yes" means the function can be activated via remote control.

Read more in the "Installer/Define/Remote Control/Tariff EL" chapter.

Ext. boiler diff °C **3 (Off, 1...15)**

Compensation set point for External Boiler is set these many degrees above the set point for "Primary Flow HS1", or "DHW," or "Pool". This is in addition to the compensation made for the loss in degree minutes.

Ext. boiler schedule

This menu bar is displayed if a "Schedule" is defined for the "Tariff EL" function in the "Installer/Define/Remote Control" menu.

For more information, refer to:

- chapter "Schedule".
- section "Def. Remote Control" in the "Installer/Define" chapter for defining the remote control function.

14.10.8 Settings Cooling

Room temp. cooling °C 25.0 (18.0...30.0)

Set the desired room temperature for cooling.

Cooling permit. from outdoor T* Off (0...39/Off)

Set the outdoor temperature from which cooling will be permitted.

Active delay* 10 (1...600/Off)

Delay refers to the time (minutes) before the production of cooling is allowed when there is a need for cooling.

Heating off, delay* 10 (0...600/Off)

Delay refers to the time (minutes) from when production of heat has ended until cooling production is permitted.

Start delay* 180 (5...240)

The menu determines the delay time (minutes) from the time the cooling has been blocked (see menu bars "Ext. Block cooling" and "Block cooling schedule") until the production of cooling is permitted again.

Diff. delay calc.* 10 (1...600/Off)

Set how often (minutes) a new value for the primary flow temperature is calculated based on the measured return temperature of the cooling flow.

Cooling curve

See the description of "Cooling curve" in this chapter.

Max primary flow °C 20 (2...40)

The maximum temperature of the cooling flow allowed out to the respective heating circuit.

Min primary flow °C 18 (2...40)

The minimum temperature of the cooling flow allowed out to the respective heating circuit.

Min flow temp cooling °C 18 (2...30)

The minimum temperature of the cooling flow allowed out to the respective heating circuit.

This setting overrides the value set in the menu bar "Min. primary flow °C".

A 4-digit code (4002) must be entered to set the menu.

Max diff. room temp. cooling °C 5 (0...20)

Specify how many degrees of difference is permitted between the primary flow temperature of the cooling flow and the room temperature.

A 4-digit code (4002) must be entered to set the menu.

Primary flow diff. at outdoor +20 °C* 2 (1...10)

Specify how many degrees of difference is permitted between the primary flow and return temperature of the cooling flow at an outdoor temperature of 20 °C.

Primary flow diff. at outdoor +40 °C* 2 (1...10)

Specify how many degrees of difference is permitted between the primary flow and return temperature of the cooling flow at an outdoor temperature of 40 °C.

Setting	Value
Room temp. cooling °C	25.0 (18.0...30.0)
Cooling permit. from outdoor T °C	Off (0...39/Off)
Active delay	10 (1...600/Off)
Heating off delay	10 (0...600/Off)
Start delay	180 (5...240)
Diff. delay calc.	10 (1...600/Off)
Cooling curve	
Max primary flow °C	20 (2...40)
Min primary flow °C	18 (2...40)
Min Flow Temp Cooling °C	18 (2...30)
Max. diff. room temp. cooling °C	5 (0...20)
Primary flow diff at outdoor T +22	2 (1...10)
Primary flow diff at outdoor T +42	2 (1...10)
Tank max °C	30
Tank min °C	5
Max time Cooling (min)	20
SmartGrid Low price °C	Off
SmartGrid Overcapacity °C	Off
Ext. block cooling	Yes
Block cooling schedule	

Menu: "Installer/Settings/Cooling".

- A 4-digit code (4002) must be entered to set the menu "Min. flow temp. cooling" and "Max. diff. room temp. cooling".

When lowering the temperature, any risk of condensation must be taken into account!

If the system is condensation-proofed, significantly lower temperatures are permitted at various points in the system.
! WARNING! Build-up of condensation in the house structure can lead to damp and damage from mildew.

In the event of doubt, contact a professional for an assessment.

*This menu bar is only displayed if active cooling has been defined in the "Installer/Define/Cooling" menu.

Tank max °C **30 (10...50)**

This menu specifies the maximum permissible temperature in the tank when cooling demand is active.

Tank min °C **5 (5...50)**

This menu specifies the minimum permissible temperature in the tank when cooling demand is active.

Max time Cooling (min.) **20 (1...150)**

Specify the maximum time that the heat pump is permitted to produce cooling if there is another need.

SmartGrid Low price °C **Off (Off/1...5)**

The setpoint for room temperature is decreased by the value set in this menu when "SmartGrid Low price" is active.

The menu bar is displayed if SmartGrid have been defined in the "Installer/Define/Remote Control" menu.

Read more in the "Remote Control/SmartGrid" section of the "Installer/Define" chapter.

SmartGrid Overcapacity °C **Off (Off/1...5)**

The setpoint for room temperature is decreased by the value set in this menu when "SmartGrid Overcapacity" is active.

The menu bar is displayed if SmartGrid have been defined in the "Installer/Define/Remote Control" menu.

Read more in the "Remote Control/SmartGrid" section of the "Installer/Define" chapter.

Ext. block cooling **No (Yes/No)**

Blocking cooling can be remote controlled remotely. For example, the function can be used to turn off cooling with the help of a humidity sensor when there is a risk of condensation.

This menu bar is displayed if the criteria below are met:

- a remote control input has been defined for the "Block cooling" function.
- a normal mode (Normally Open (NO) or Normally Closed (NC)) for the external control signal has been defined on the menu bar "Block cooling ext. config." in the "Installer/Define/Cooling" menu.

Read more in the "Def. Remote Control" section of the "Installer/Define" chapter.

Block cooling schedule

This menu is used to schedule the weekday periods during which cooling should be blocked. This schedule is repeated every week.

This menu bar is displayed if a schedule has been defined for the "Block Cooling" function, in the "Installer/Define/Remote Control" menu.

For more information, refer to:

- chapter "Schedule".
- section "Def. Remote Control" of the "Installer/Define" chapter for defining the remote control function.

Cooling curve

The cooling curve determines the primary flow temperature (and thus the indoor temperature) to the heating circuit at different outdoor temperatures.

Possible choices are "Set. cooling curve", "Fine adjustment", "Active curve", "Copy from ..." and "Reset curve".

The specified min. and max. values of the cooling flow define the operating range of the system (the light-colored field between the grey areas in the menu screens "Set. Cooling curve").

• Set. Cooling curve

Here it is possible to adjust the appearance of the graph by adjusting the curve inclination and curve adjustment with the buttons below the graph. The adjustments you make here affect the entire appearance of the graph, while the changes made under "Fine adjustment" are made one point at a time. Curve inclination is adjusted with the left and right arrows while curve adjustment is adjusted with the up and down arrows. Confirm with "OK".

• Fine adjustment

The graph of the active cooling curve for the heating circuit is displayed. The cooling curve can be adjusted in 5 points on the graph. Touch a point (becomes green) to change its position in the x-axis (outdoor temperature) and y-axis (primary flow temperature). Use the up/down/left/right buttons below the graph or press and drag the point.

Below the graph, the outdoor and primary flow temperatures for the selected point are shown. The cooling curve can also be adjusted from the "Heating/Cooling" menu. See chapter "Control system/Heating/Cooling".

• Active curve

1 (1/2)

This menu bar shows the selected cooling curve, it is possible to choose between two different cooling curves per heating circuit.

• Copy from 1 (2)

The function "Copy from ..." is useful if you have created two different cooling curve graphs but want to restore one graph to the same appearance as the other and then make changes.

Example: If cooling curve 1 is selected as "Active curve", cooling curve 1 will have the same appearance as cooling curve 2 by selecting the line "Copy from 2" and pressing "OK". The menu bar cannot be selected (marked with gray) when cooling curves 1 and 2 have the same values (the graphs look the same).

• Reset curve

Resets the active cooling curve to the factory-set curve.

i The specified min. and max. values of the cooling flow define the operating range of the system (the light-colored field between the grey areas in the menu screens "Set. Cooling curve").

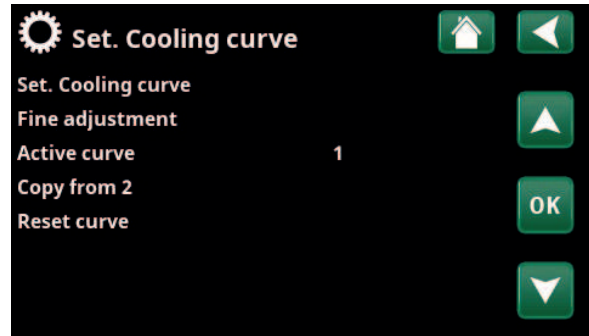

Menu "Installer/Settings/Cooling/Cooling curve/Set. Cooling curve".

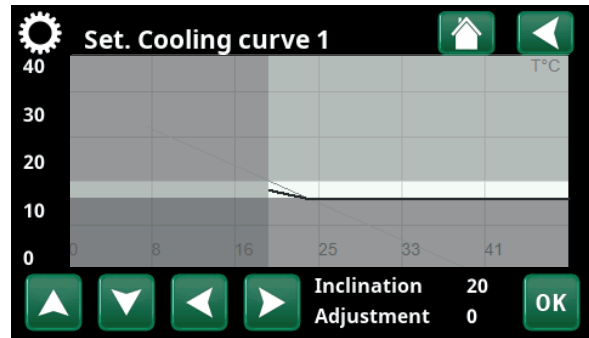

Menu "Installer/Settings/Cooling/Cooling curve/Set. Cooling curve".

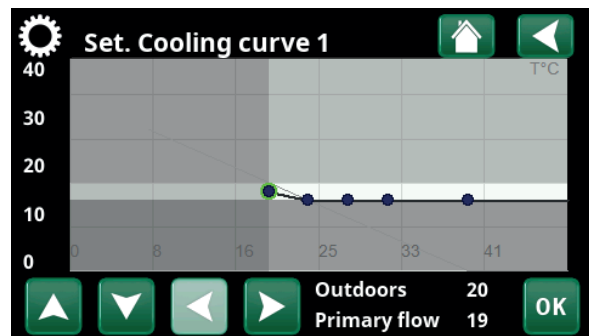

Menu "Installer/Settings/Cooling/Cooling curve/Fine adjustment".

Example Cooling curve

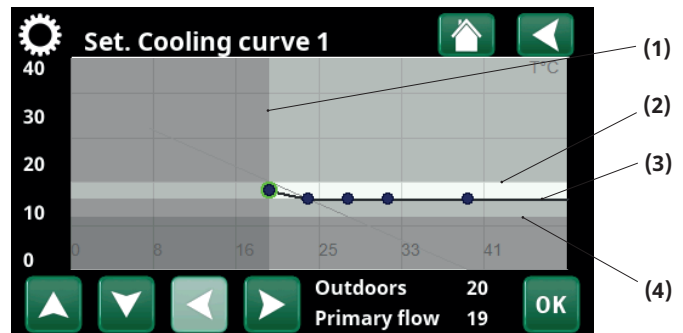

Menu "Installer/Settings/Cooling/Cooling curve/Fine adjustment".

Menu "Settings Cooling"	Setting "Example Cooling curve"
(1) Cooling permit. from outdoor °C	20
(2) Max primary flow °C	20
(3) Min primary flow °C	18
(4) Min flow temp cooling °C (Coded settings)	16

14.10.9 Settings Communication

Settings can be made here to control the product with a control system.

14.10.9.1 Settings Ethernet

DHCP **Yes (Yes/No)**

"Yes" enables automatic connection to the network.

If "No", custom router settings (IP address, Netmask and Gateway) as well as DNS setting must be made.

Auto DNS **Yes (Yes/No)**

If "Yes", default DNS server settings are used. If "No", custom DNS settings must be made.

SNTP Server

Option for custom SNTP server settings.

Connection speed **100mbit**

Connection speed is specified here.

The factory-set connection speed is 100 mbit/s.

For more information about connecting an ethernet cable, refer to the "Installation, Communication" chapter of this manual.



Menu: "Installer/Settings/Communication".

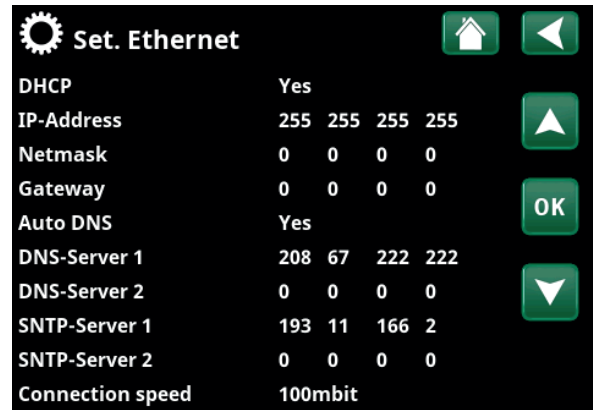

Menu: "Installer/Settings/Communication/Internet".

14.10.9.2 Settings BMS

MB address **1 (1...255)**

Adjustable "1-255".

Baudrate **9600 (9600/19200)**

Possible settings: "9600" or "19200".

Parity **Even (Even/Odd/None)**

Possible settings: "Even", "Odd" or "None".

Stop bit **1 (1/2)**

Possible settings: 1 or 2.

Modbus TCP Port **502 (1...32767)**

This menu bar is displayed if "Modbus TCP" is defined in the "Ethernet" row in the "Installer/Define/Remote Control" menu.

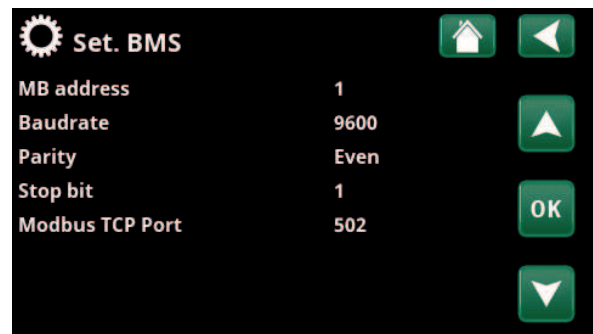

Menu: "Installer/Settings/Communication/BMS".

14.10.9.3 myUplink

The menu is used for pairing with the myUplink app. Request connection string by pressing "Get connection string", confirm with "OK". The menu bar is clickable if the display is connected to the server.

In the app: Scan the QR code or enter values for "Serial number" and "Connection string".

Select the menu items "Remove users" and / or "Remove service partners" to disconnect these accounts from the system. Confirm with "OK".



Menu: "Installer/Settings/Communication/myUplink".

14.10.9.4 Settings El. prices

Ensure that "myUplink" is selected in the "Def. Communication" menu.

Select "El.prices" in the "Installer/Settings/Communication" menu to access the "Set. El.prices" menu.

Price control On/Off

Select "On" to show the other menu lines of the "Set. El.prices" display menu.

Regions SE01/SE02/SE03/SE04

Click "OK" on the "Regions" line. If "Regions" are defined for the selected country (see "Installer/Display/Country" menu), price regions for the country are shown here. Otherwise, the text "No regions available" is displayed. In this example, Swedish price regions are displayed.

Dynamic Yes/No

"Yes" means that the electricity prices are calculated according to price algorithms that define the price categories ("High", "Medium" and "Low").

Click "OK" on the "Preview data" line to display a graph of electricity prices calculated over the selected time interval ("Days in calculation").

The graph can also be displayed by clicking the "El.prices" icon in the "Operation" main menu (see "Operation" section).

Limit value high

Set the limit value above which the electricity price is defined as "High" (in the example, the limit value is SEK 3.50). This can be used together with the dynamic price calculation feature to define a different "High" price range than that determined by the dynamic price calculation feature.

Prices defined as "High" activate the "SmartGrid Blocking" function.

Limit value low

Set the limit value below which the electricity price is defined as "Low" (in the example, the limit value is SEK 1.50). This can be used together with the dynamic price calculation feature to define a different "Low" price range than that determined by the dynamic price calculation feature.

Prices defined as "Low" activate the "SmartGrid Low price" function.

Default High/Medium/Low

Select the price category that should apply if prices cannot be retrieved.

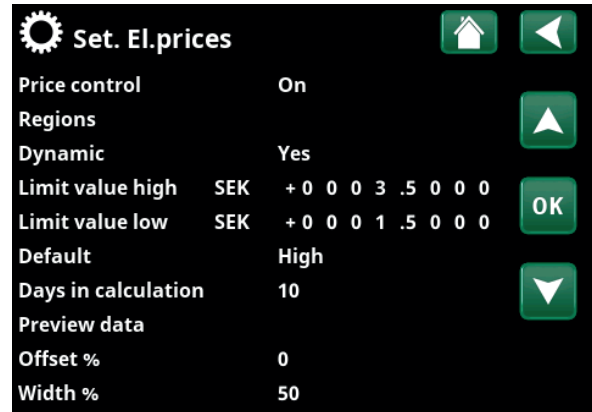

Menu: "Installer/Settings/Communication/El.prices" where "Installer/Define/Communication/myUplink:Yes" is selected.

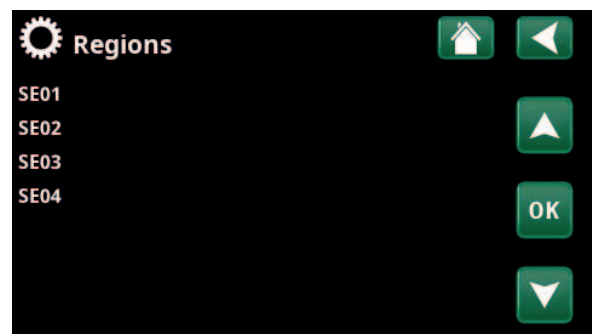

Menu: "Installer/Settings/Communication/El.prices/Regions" where "Installer/Define/Communication/myUplink:Yes" is selected

For more information and examples of Smart Electricity Price Control/SmartGrid, see the website www.ctc-heating.com/Products/Download.

Days in calculation**1...10**

Select the number of days on which the dynamic calculation of the electricity price will be based. Since the dynamic calculation is based on the average price per day, more days in calculation result in a more stable and reliable value.

See also the "Example: Electricity price settings" section.

Preview data

Click "Preview data" to show electricity prices during the selected period in graph form.

Offset %**0 (0...100)**

Enter code "4003" in the "Installer/Service/Coded settings/Code" menu to display the "Offset %" menu line.

"Offset" is the boundary between where "High" price and "Medium" price electricity is determined and is based on the average price for the number of days used in the calculation.

See also the "Example: Electricity price settings" section.

Width %**50 (0...200)**

Enter code "4003" in the "Installer/Service/Coded settings/Code" menu to display the "Width %" menu line.

"Width" is the vertical price range where the electricity price is considered "Medium".

See also the "Example: Electricity price settings" section.

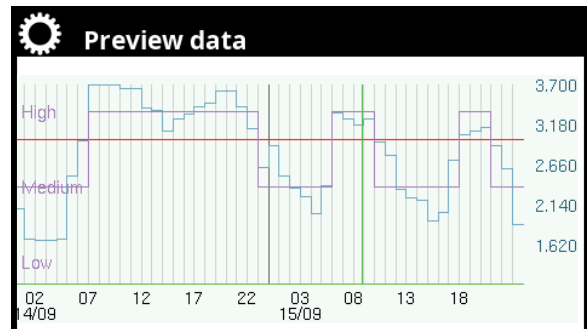

Menu: "Installer/Settings/Communication/El.prices/Preview data".

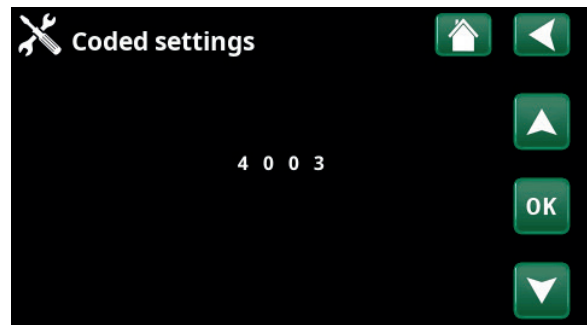

Menu: "Installer/Service/Coded settings/Code".

14.10.10 Settings Current sensor

These menu bars are displayed if "Current Sensor" is defined in the "Installer/Define Current Sensor" menu.

In the menu, specify the phases (L1, L2 and L3) to which the current sensors have been connected.

In the lower left corner of the screen, "Invalid configuration" will be displayed until L1, L2, and L3 are paired with the three current sensors in the menu.

When activating the "Auto config. current sensors" function, it is important that you have switched off all devices in the house that consume high levels of electricity. Also make sure that the backup thermostat is switched off.

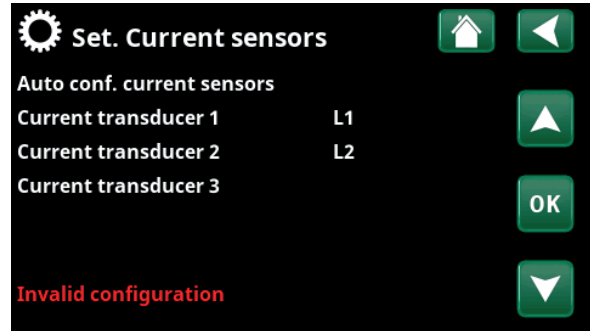

Menu: "Installer/Settings/Current Sensors".

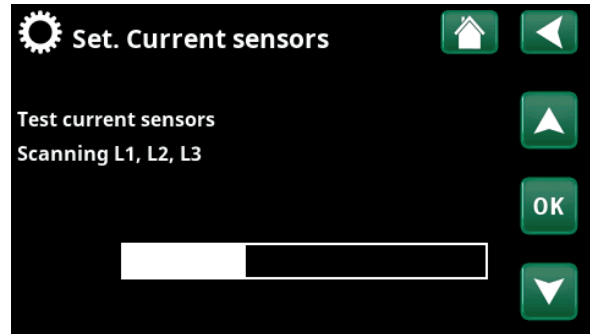

Menu: "Installer/Settings/Current Sensors /Auto config. current sensor".

14.10.11 Settings Round circulation schedule

Round circulation is equipment which an electricity supplier can fit in order to disconnect, for a short period of time, equipment which draws high current. The compressor and electrical output are blocked when Round circulation is active.

This menu bar is displayed if a schedule has been defined for the "Round circulation" function.

The "Round circulation" function can also be controlled remotely by activating the "Input" defined for the function.

For more information, refer to:

- chapter "Schedule".
- section "Def. Remote Control" of the "Installer/Define" chapter for defining the remote control function.

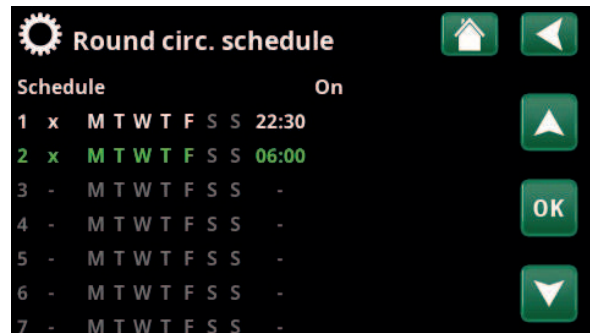

Menu: "Installer/Settings/Round circulation".

14.10.12 Settings SmartGrid schedule

This menu is used to schedule the weekday periods during which the "SmartGrid" functions should be active. This schedule is repeated every week.

"SmartGrid" can be used to block a function ("SG Block.") or to achieve a temperature increase during periods when the energy price is low ("SG Low price") or ("SG Overcapacity").

SG Normal mode can be used to easily deviate from any SmartGrid settings for the system on specific days/at specific times.

The "SmartGrid schedule" menu bar is displayed if a schedule has been defined in the "SmartGrid A" row.

For more information, refer to:

- chapter "Schedule".
- chapter "Installer/Define/Remote Control" for defining SmartGrid.

14.10.13 Save settings

Custom settings can be saved to "Bank" 1-3 and on a USB drive here. The "USB" row is greyed out until the USB drive is installed. The rows show the date and time of saved settings.

Press "OK" to confirm.

14.10.14 Load settings

The saved settings can be recovered.

Press "OK" to confirm.

14.10.15 Load Factory settings

The product is supplied with the factory values set. Saved settings in "Bank" 1-3 are deleted when factory settings are restored. The selected language is recovered.

Press "OK" to confirm.



Menu: "Installer/Settings/SmartGrid schedule".

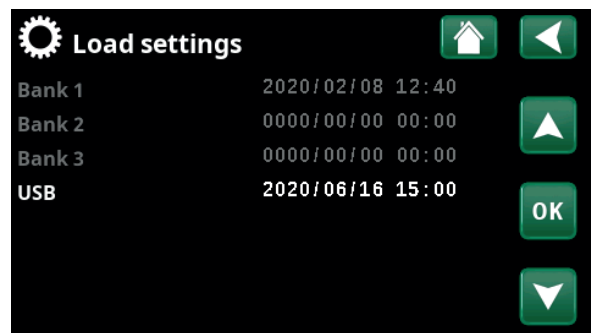

Menu: "Installer/Settings/Load My Settings".



14.11 Define

The "Define" menus specify which components and subsystems the system consists of.

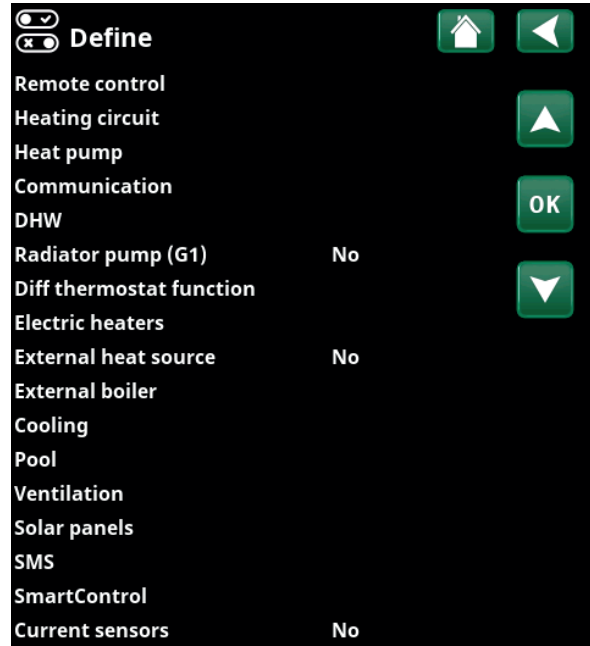

Menu: "Installer/Define".

14.11.1 Def. Remote control

This chapter describes all remote control functions; how they are set up and how they are used.

The "Installer/Define/Remote Control" menu defines how the remote control inputs should be activated by specifying one of the following three modes of activation in the "Input" column of this menu:

- a terminal block K22-K23 on the relay card (A2) has power or terminal block K24-K25 is closed. There are two 230 V inputs and two low voltage ports. See table below.
- wireless accessories in the CTC SmartControl series consist of wireless sensors and control units that control signals for temperature, humidity and carbon dioxide level.
- BMS control where control signals are transmitted via the BMS interface.

If you want a function to recur during weekdays, you can set when the function should be active/inactive in a schedule.

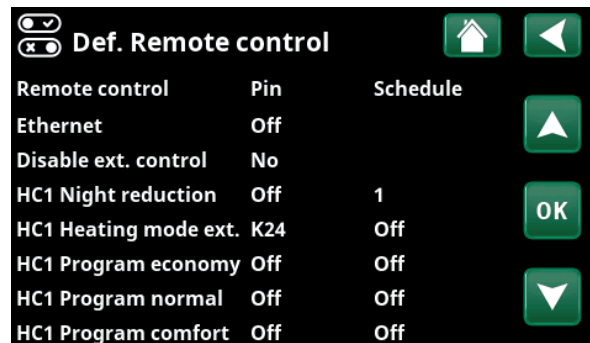

Part of the "Installer / Define/Remote Control" menu.

Designation	Terminal block position	Connection type
K22	A14 & A25	230V
K23	A24 & A25	230V
K24	G33 & G34	Extra-low voltage (<12V)
K25	G73 & G74	Extra-low voltage (<12V)

The table shows the remote control inputs K22-K25 on the relay card.

14.11.1.1 Setting the remote control function, example

1. Define an "Input"

First, an input must be assigned to the function or functions to be controlled remotely. This is done in the "Installer/Define/Remote Control" menu.

In the example, terminal block K24 is selected as the input for the "HC1 Heating mode, Ext." function.

2. Configure the function (Normally Open (NO)/Normally Closed (NC))

Define a normal mode for the external control signal; NO or NC. The setting is made for the current heating circuit in the "Installer/Define/Heating Circuit" menu.

For example, a two-way switch can be connected to the defined input.

If the button when used generates a control signal on the input (circuit closes), the circuit shall be defined as NO. When the circuit closes and the control signal is generated, the heating mode selected in the "HC1 Heating mode, ext." row is activated in the settings menu for the heating circuit.

3. Setting the heating mode

In the example, the remote control function "Heating mode, ext." is set to the "Off" position in the "Heating mode, ext." row. This setting is made in the "Installer/Settings/heating circuit" menu.

In this example, the normal heating mode is active ("On").

When input K24 is closed (the multi-button in the example generates a control signal), the status of the Heating Mode (normal mode "On" > mode "Off") changes.

Heating remains off until you choose to start the heating (normal mode "On") by opening terminal block K24 (no signal on the terminal block).

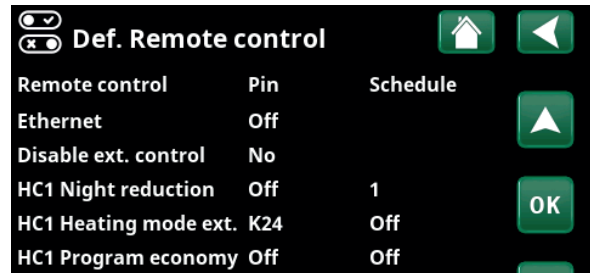

Menu: "Installer/Define/Remote Control".
Remote control function "HC1 Heating mode, ext." is assigned to terminal block "K24".

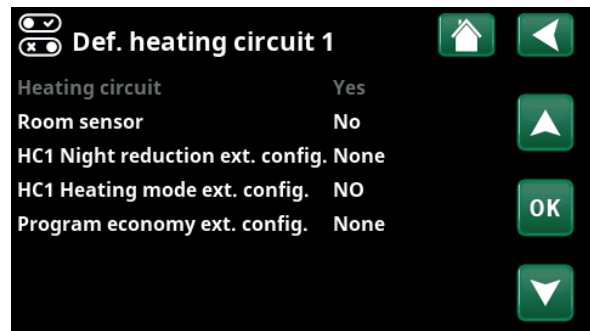

Menu: "Installer/Define/Heating Circuit/ Heating Circuit 1".
The normal mode of the remote control signal is defined in the "HC1 Heating mode ext. config" row.

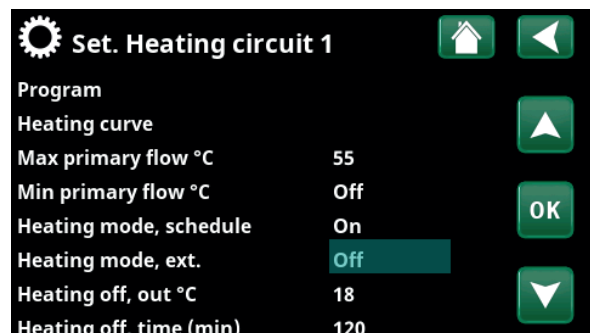

Menu: "Installer/Settings/Heating Circuit/ Heating Circuit 1" Remote control mode "Off" becomes active when terminal block K24 closes.

Open terminal block = Heating mode "On" (in this example).
Closed terminal block = Heating mode "Off" (in this example).

14.11.1.2 Remote control functions

The "Installer/Define/Remote Control" menu defines Inputs for current remote control functions:

- Inputs K22, K23, K24, K25.
- wireless accessories in the SmartControl series (Channel 1A, 1B, 2A, 2B, 3A, 3B and so on up to 7B).
- BMS digital input 0-7. Specify a value 0-255. The value must be set again within half an hour for the setting to persist.

Ethernet (Modbus TCP/Off)

For information about Modbus TCP Port settings, refer to the "Communication" section in the "Installer/Settings" chapter.

Disable ext. control (Yes/No)

Selection "Yes" means disconnecting all external control of the heat pump. Schedule settings are not affected.

HC1- Night reduction (Off/K22-K25/Channel 1A-7B / BMS DI0-7)

The "Night Reduction" function can be used to, for example, lower the indoor temperature during the night or during working hours.

In the "Installer / Define/Remote Control" menu:

- specify an "Input" for the remote control function.

In the "Installer / Define/Heating Circuit" menu:

- configure the normal mode for the external control signal (Normally Open (NO)/Normally Closed (NC)).

The schedule can be set in the "Heating/Cooling" menu.

For more information, refer to the "Night Reduction Temperature" section in the "Heating/Cooling" chapter.

HC1- Heating mode, ext. (Off/K22-K25/Channel 1A-7B / BMS DI0-7)

Switching between heating season and summer season can take place at a specific outdoor temperature (Auto) or heating can be either always "On" or "Off".

In the "Installer / Define/Remote Control" menu:

- specify an "Input" for the remote control function.

In the "Installer / Define/Heating Circuit" menu:

- configure the normal mode for the external control signal (Normally Open (NO)/Normally Closed (NC)).

In the "Installer / Settings/Heating Circuit" menu:

- set "Remote Control Mode" ("On", "Off" or "Auto") in the "Heating mode, ext." row.
- Access function scheduling from the "Heat mode, schedule" row.

For more information, refer to the "Heating Circuit" section in the "Installer/Settings" chapter. Also refer to the "Your home's heating settings" chapter.

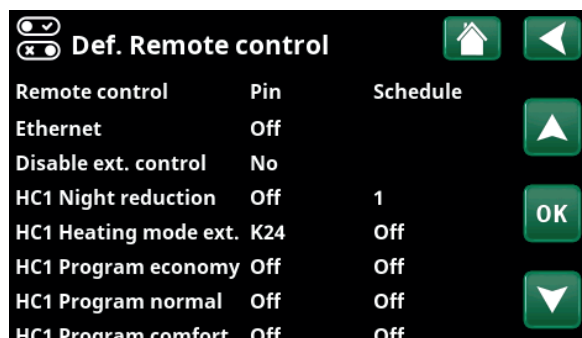

Part of the "Installer/Define/Remote Control" menu. "Input" and "Schedule" are defined here.

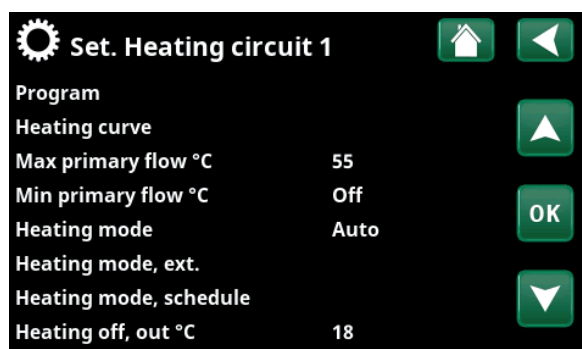

Menu: "Installer/Settings/Heating Circuit". The remote control mode for the heating circuit is set on menu bar "Heating mode, ext.". Access the schedule from the menu bar "Heating mode, schedule".

HC1- Program economy/normal/comfort/custom ext. config. (Off/K22-K25/Channel 1A-7B / BMS DI0-7)

The program functions "Economy", "Normal" "Comfort" and "Custom" can be used to change the indoor temperature for a certain period.

In the "Installer/Define/Remote Control" menu:

- specify an "Input" for the remote control function.

In the "Installer/Define/Heating circuit":

- configure the normal mode for the external control signal (Normally Open (NO)/Normally Closed (NC))

Setting the schedule is done from the "Heating/Cooling/Program" menu.

For more information, see section "Heating program" in chapter "Heating/Cooling".

Extra DHW (Off/K22-K25/Channel 1A-7B / BMS DI0-7)

Upon activation, production of extra DHW begins. When activation stops, extra DHW is produced for a run-on time of 30 min. The "Stop temperature" for extra DHW is set in the "Installer/Settings /DHW Tank/DHW program" menu.

In the "Installer/Define/Remote Control" menu:

- specify an "Input" for the remote control function.

In the "Installer/Define/DHW" menu:

- configure the normal mode for the external control signal (Normally Open (NO)/Normally Closed (NC)) in the "Extra DHW" row.

Setting extra DHW production to start immediately can also be done in the "DHW" menu. The schedule for extra DHW can also be set in this menu.

For more information, refer to the "Extra DHW" section in the "DHW" chapter.

Block cooling

(Off/K22-K25/Channel 1A-7B / BMS DI0-7)

In the "Installer/Define/Remote Control" menu:

- specify an "Input" for the remote control function.

In the "Installer/Define/Cooling" menu:

- configure the normal mode for the external control signal (Normally Open (NO)/Normally Closed (NC)).

In the "Installer/Settings/Cooling" menu:

- set the "remote control mode" ("On") in the "Ext. block. cooling" row.
- Access function scheduling from the "Block cooling schedule" row.

For more information, refer to the "Cooling" section in the "Installer/Settings" chapter.

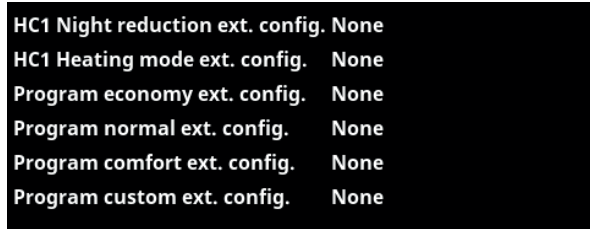

Part of the "Installer/Define/Heating circuit" menu. In the menu bars "Program economy/normal/comfort/custom ..." the normal mode is indicated on the external control signal ("Normally Open (NO)" or "Normally Closed (NC)").

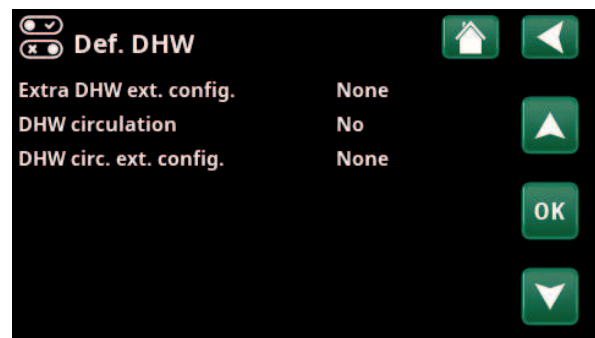

Menu: "Installer/Define/DHW" On menu bar "Extra DHW", the normal mode is specified for the external control signal ("Normally Open (NO)" or "Normally Closed (NC)").

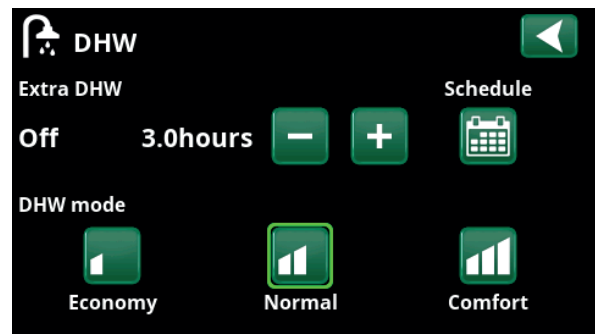

Setting the "Extra DHW" in the "DHW" menu.

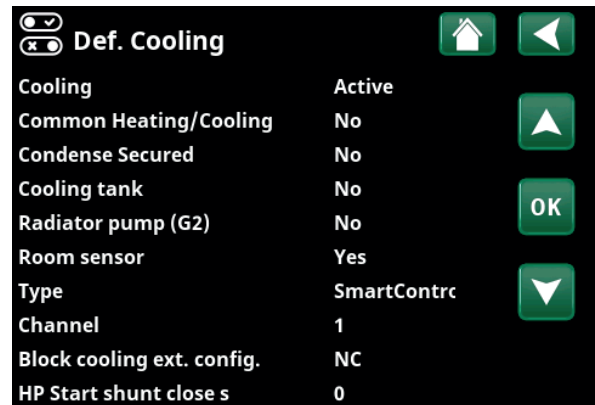

On menu bar "Block. cooling ext. config.", the normal mode is specified for the external control signal ("Normally Open (NO)" or "Normally Closed (NC)").

Tariff EL (Off/K22-K25/Channel 1A-7B/BMS DI0-7)

This function is used to block the immersion heater during periods when the electricity rate is higher.

In the "Installer/Define/Remote Control" menu:

- specify an "Input" for the remote control function.

In the "Installer/Settings/Additional Heat" menu:

- set "remote control mode" ("Yes") in the "Tariff EL" row.
- Access function scheduling from the "Tariff EL" row.

For more information, refer to the "Additional Heat/Tariff EL" section in the "Installer/Settings" chapter.

Round circulation

(Off/K22-K25/Channel 1A-7B/BMS DI0-7)

Round circulation is equipment which an electricity supplier can fit in order to disconnect, for a short period of time, equipment which draws high current. The compressor and electrical output are blocked when round circulation is active.

In the "Installer/Define/Remote Control" menu:

- specify an "Input" for the remote control function.

In the "Installer/Settings" menu:

- Access function scheduling from the "Round circulation" row.

For more information, refer to the "Round circulation" section in the "Installer/Settings" chapter.

Flow/level switch

(Off/K22-K25/Channel 1A-7B/BMS DI0-7)

The flow/level switch produces an alarm on the heat pump.

In the "Installer/Define/Remote Control" menu:

- specify an "Input" for the remote control function.

In the "Installer/Define/Heat Pump" menu:

- configure the normal mode for the external control signal (Normally Open (NO)/Normally Closed (NC)) in the "Flow/level switch" row.

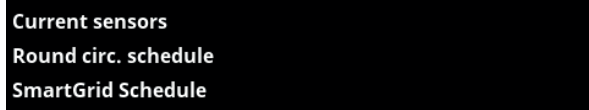

Part of the "Installer/Settings" menu. Setting a "Round circulation" schedule.

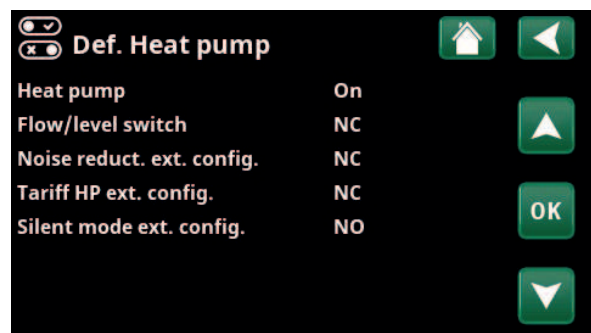

Menu: "Installer/Define/Heat Pump".
A mode for the external control signal ("Normally Open (NO)" or "Normally Closed (NC)").

SmartGrid A / SmartGrid B
(Off/K22-K25/Channel 1A-7B / BMS DI0-7)

In the "Installer/Define/Remote Control" menu:

- specify an "Input" for the remote control function.

There are three SmartGrid functions:

- SmartGrid Low Price
- SmartGrid Overcapacity
- SmartGrid Blocking

Example of "SmartGrid Low Price" for pool heating

In this example, "SmartGrid A" and "SmartGrid B" have been assigned terminal blocks K22 and K23, respectively. In addition, SmartGrid A is assigned "Schedule #1".

According to the settings in the "Set. Pool" menu, the pool setpoint will be increased by 5°C when the electricity price is low (when the "SmartGrid Low price" function is active) and the setpoint will be decreased by 10°C* when the electricity price is high (when the "SmartGrid Blocking" function is active).

SmartGrid functions can be set (depending on system configuration/heat pump model) for Heating circuit including Heating program economy/comfort/custom, Heat pumps, Additional heating, Cooling, Pool, DHW tank, Buffer tank and Upper* and Lower* tank.

Heating circuit 1-*

- SmartGrid Blocking (Off/On)
- SmartGrid Low price °C (Off/1...5 °C)
- SmartGrid Overcapacity °C (Off/1...5 °C)

Heating program

-Comfort:

- SmartGrid Low price °C (Off/On)
- SmartGrid Overcapacity °C (Off/On)

-Custom:

- SmartGrid Low price °C (Off/On)
- SmartGrid Overcapacity °C (Off/On)
- SmartGrid Blocking (Off/On)

-Economy:

- SmartGrid Blocking (Off/On)

Heat pump*

- SmartGrid Blocking HP (Yes/No)

Additional Heat/Immersion heater

- SmartGrid Blocking EL (Yes/No)
- SmartGrid Blocking Mixing valve (Yes/No)

Cooling

- SmartGrid Low Price °C (Off/1...5 °C)
- SmartGrid Overcapacity °C (Off/1...5 °C)

Pool

- SmartGrid Blocking °C (Off/-1...-50 °C)
- SmartGrid Low Price °C (Off/1...50 °C)
- SmartGrid Overcapacity °C (Off/1...50 °C)

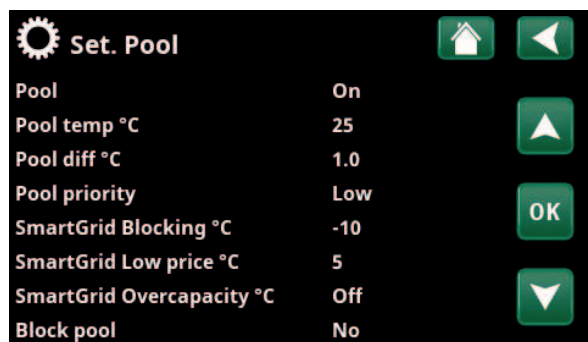

Menu: "Installer/Settings/Pool".
The pool temperature is increased by 5 °C when the SmartGrid Low Price function is activated.

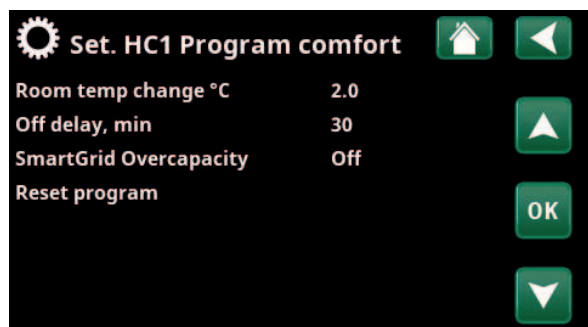

Menu "Installer/Settings/Heating Circuit/Heating Circuit 1/Program/Comfort".

*The heat pump can control up to 2 heating circuits.

DHW tank/Lower tank/Upper tank

- SmartGrid Blocking °C (Off/-1...-50 °C)
- SmartGrid Low Price °C (Off/1...30 °C)
- SmartGrid Overcapacity °C (Off/1...30 °C)

Buffer tank

- SmartGrid Low Price °C (Off/1...30 °C)
- SmartGrid Overcapacity °C (Off/1...30 °C)

SmartGrid functions are enabled by activating the SmartGrid inputs in different ways according to the table on the right.

K22 (SG A)	K23 (SG B)	Function
Open	Open	Normal
Open	Closed	Low price
Closed	Closed	Overcapacity
Closed	Open	Blocking

To enable the SmartGrid function "SG Low price" as shown in the example, terminal block K23 must have power while terminal block K22 should remain unchanged.

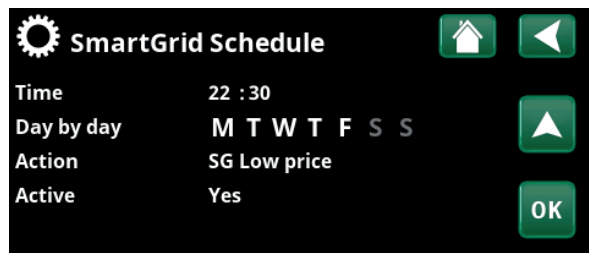

The schedule is set to start at 22:30, weekdays.

The pool temperature increase that will apply when "SG Low price" is activated is set in the "Pool Settings" menu, as shown in the example.

Alternatively, a schedule can be set up for periodic SmartGrid activation. For more information on setting schedules, refer to the "Schedule" section.

Tariff HP

(Off/ K22-K25/Channel 1A-7B /BMS DI0-7)

This function is used to block the heat pump during periods when the electricity rate is higher.

In the "Installer/Define/Remote Control" menu:

- specify an "Input" for the remote control function.

In the "Installer/Define/Heat Pump" menu:

- configure the normal mode for the external control signal (Normally Open (NO)/Normally Closed (NC)) in the "Tariff HP ext. config." row.

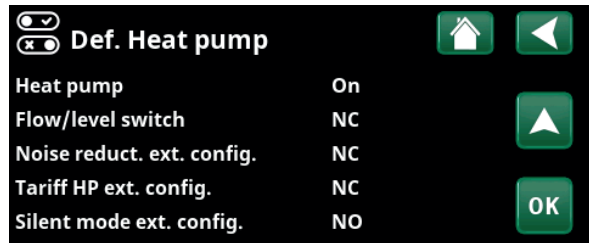

In the "Installer/Settings/Heat Pump" menu:

- set "Tariff HP" ("On").

For more information, refer to the "Heating Pump" section in the "Installer/Settings" chapter.

Menu: "Installer/Define/Heat Pump". A mode for the external control signal ("Normally Open (NO)" or "Normally Closed (NC)") is defined for "Tariff HP ext. config.", "Noise reduction ext. config." and "Silent mode ext. config.".

Diff Thermostat function

(Off/K22-K25/Channel 1A-7B / BMS DI0-7)

This function is used to block the diff thermostat function.

In the "Installer/Define/Remote Control" menu:

- specify an "Input" for the remote control function.

In the "Installer/Define/Diff thermostat function" menu:

- configure the normal mode for the external control signal (Normally Open (NO)/Normally Closed (NC)) in the "Blocking diff thermostat ext. config." row.

For more information, refer to the "Diff thermostat function" section in the "Installer/Settings" chapter.

HP Noise reduction

(Off/K22-K25/Channel 1A-7B / BMS DI0-7)

This function can be used to reduce compressor speed in order to reduce the noise level.

In the "Installer/Define/Remote Control" menu:

- specify an "Input" for the remote control function.

In the "Installer/Define/Heat Pump" menu:

- configure the normal mode for the external control signal (Normally Open (NO)/Normally Closed (NC)) in the "Noise reduction ext. config." row.

In the "Installer/Settings/Heat Pump" menu:

- in the "Ext. noise reduction RPS" row, set the compressor speed value applicable for remote control.

For more information, refer to the "Heating Pump" section in the "Installer/Settings" chapter.

HP Night Mode

(Off/K22-K25/Channel 1A-7B / BMS DI0-7)

This function can be used to reduce compressor speed and fan speed in order to reduce the noise level.

Only applies to air-to-water heat pumps.

In the "Installer/Define/Remote Control" menu:

- specify an "Input" for the remote control function.

In the "Installer/Define/Heat Pump" menu:

- configure the normal mode for the external control signal (Normally Open (NO)/Normally Closed (NC)) in the "Silent mode ext. config." row.

For more information, refer to the "Heating Pump" section in the "Installer/Settings" chapter.

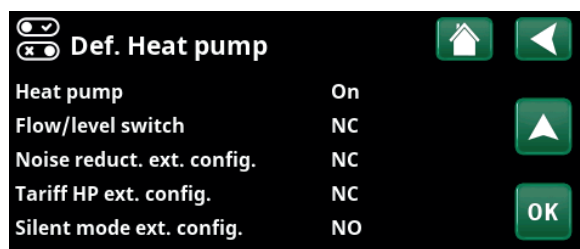

Menu: "Installer/Define/Heat Pump".

A mode for the external control signal ("Normally Open (NO)" or "Normally Closed (NC)") is defined for "Noise reduction ext. config.".

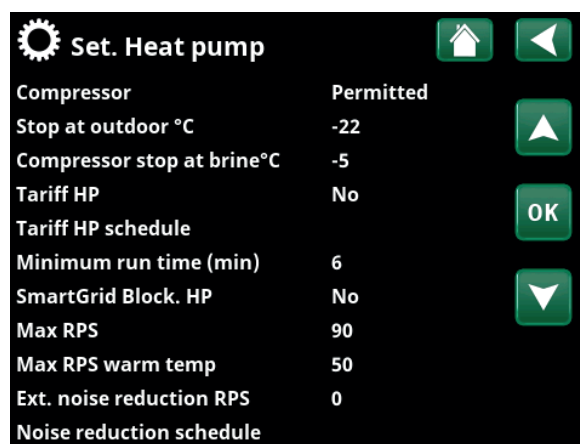

Menu: "Installer/Settings/Heat Pump".

Set the compressor speed value applicable for remote control in the "Ext. noise reduction RPS" row.

14.11.2 Def. Heating Circuit

Heating Circuit 1 Yes (Yes/No)

Heating Circuit 1 (HC 1) is predefined by the control system. Heating Circuit 2 is shown on the row underneath if connected.

Room sensor Yes (Yes/No/Show)

Selection "Yes" means that room sensors should be connected to the heating circuit.

If "Show" is selected, the room temperature is displayed but the room sensor is not used for control.

Type Wireless (Cable/Wireless/SmartControl)

Select whether the room sensor for the heating circuit has a wired (via cable) or wireless connection.

- **Wireless**
Select "Wireless" to connect CTC's wireless room sensors to the heating circuit. Refer to the "CTC Wireless Room Sensor" manual for information on how to connect these sensors.
- **SmartControl**
SmartControl is a separate series of wireless accessories. If "SmartControl" is selected, the connection channel must be selected in the row below. SmartControl accessories are connected to the system via the "Installer/Define/SmartControl" menu. Refer to the separate SmartControl Accessories manual.

HC1- Night reduction ext. config. None (None/NO/NC)

This menu defines the Normally Open (NO) or Normally Closed (NC) mode for the external control signal when remotely controlling the function.

For examples of how to set the normal mode, refer to the "Installer/Define/Remote Control" chapter.

HC1- Heating mode ext. config. None (None/NO/NC)

This menu defines the Normally Open (NO) or Normally Closed (NC) mode for the external control signal when remotely controlling the function.

For examples of how to set the normal mode, refer to the "Installer/Define/Remote Control" chapter.

Program * ext. config. None (None/NO/NC)
***economy/normal/comfort/custom**

This menu defines the Normally Open (NO) or Normally Closed (NC) mode for the external control signal when remotely controlling the function.

For examples of how to set the normal mode, refer to the "Installer/Define/Remote Control" chapter.

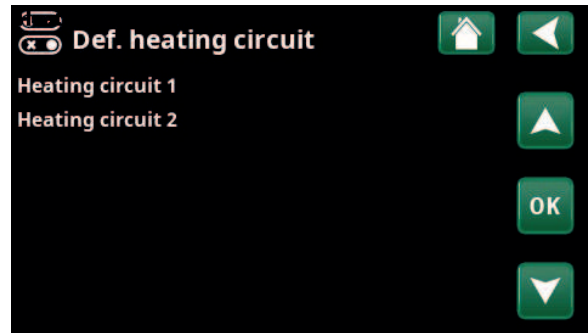

Menu: "Installer/Define/Heating Circuit".
Select a heating circuit and press "OK" to access the settings.

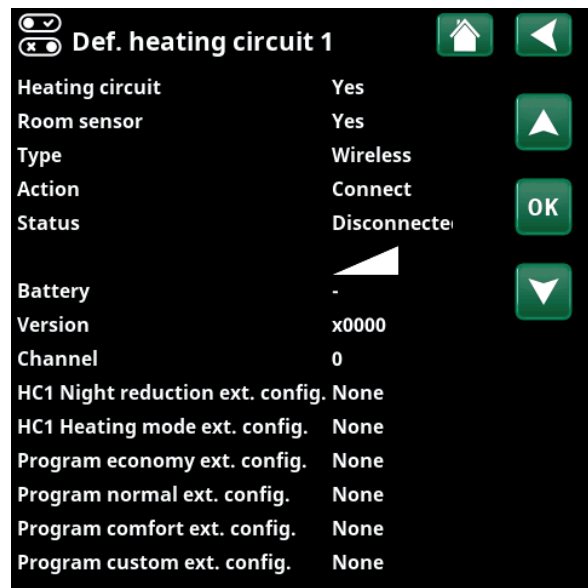

Menu: "Installer/Define/Heating Circuit/ Heating Circuit 1".
Wireless room sensor selected.

14.11.3 Def. Heat pump

Heat pump **Off (On/Off)**

Select whether the heat pump should be On or Off.

Flow/level switch **None (None/NC/NO)**

This menu bar is displayed if an "Input" for remote control is defined for the "Flow/level switch" function in the "Installer/Define/Define Remote Control" menu.

Noise reduct. ext. config. **None (None/NC/NO)**

This menu bar is displayed if an "Input" for remote control is defined for the "HP Noise Reduction" function in the "Installer/Define/Remote Control" menu.

Tariff HP ext. config. **None (None/NC/NO)**

This menu bar is displayed if an "Input" for remote control is defined for the "HP Tariff" function in the "Installer/Define/Remote Control" menu.

Silent mode ext. config.* **None (None/NC/NO)**

This menu bar is displayed if an "Input" for remote control is defined for the "Silent Mode" function in the "Installer/Define/Remote Control" menu.

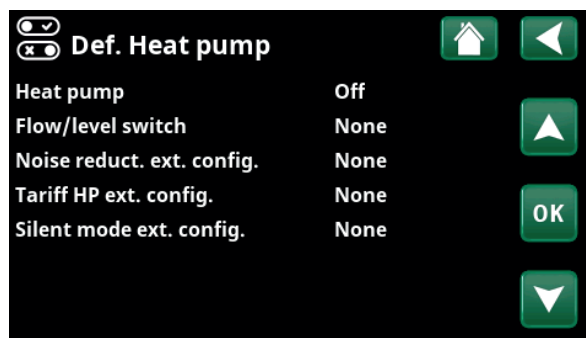

Menu: "Installer/Define/Heat Pump".

14.11.4 Def. Communication

myUplink **No (Yes/No)**

Select "Yes" to connect to the heat pump from the myUplink app.

Web **No (Yes/No)**

Select "Yes" to connect to the local web server. Internet router and firewall required.

El.prices **myUplink/myUplink ext./BMS/No**

Select "myUplink" to connect the heat pump to the myUplink mobile app for electricity price control.

Select "myUplink ext." to connect via myUplink to an external price control app. This option is not available at the moment.

Select "BMS" to connect via property management.



Menu: "Installer/Define/Communication".

i For more information, see the "Installation Communication" chapter of this manual.

*Only applies to air-to-water heat pumps.

14.11.5 Def. DHW

Extra DHW ext. config. **None (None/NC/NO)**

This menu defines the Normally Open (NO) or Normally Closed (NC) mode for the external control signal when remotely controlling the function.

For examples of normal mode settings, refer to the "Def. Remote Control" section of the "Installer/Define" chapter.

DHW circulation **No (Yes/No/DHW)**

"**Yes**" DHW circulation (DHW circ.) with circulation pump G40 must be defined. This functionality option requires the Expansion Card (A3) accessory in order for DHW circulation to be monitored by the product.

"**DHW**" Alternative with external DHW circ. pump which is not controlled by the product. Does not require expansion card (A3).

DHW circ. ext. config. **None (None/NC/NO)**

This menu defines the Normally Open (NO) or Normally Closed (NC) mode for the external control signal when remotely controlling the function.

For examples of normal mode settings, refer to the "Def. Remote Control" section of the "Installer/Define" chapter.

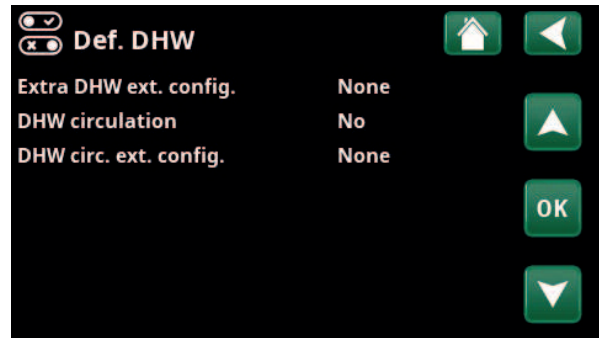

Menu: "Installer/Define/DHW".

14.11.6 Def. Diff thermostat function

Diff Thermostat function **No/Yes**

Specify here whether Diff thermostat function is used. The differential thermostat function is used if you want to charge your EcoZenith from a water-jacketed stove, or another heating source.

However, this function cannot be combined with the same function in a solar heating circuit (when e.g. an EcoTank is connected to an EcoZenith i360). This is because the same outlets and sensors are used for both functions.

Blocking diff thermostat ext. config. **None (None/NC/NO)**

This menu defines the Normally Open (NO) or Normally Closed (NC) mode for the external control signal when controlling the function remotely.

For examples of normal mode settings, refer to the "Def. Remote Control" section of the "Installer/Define" chapter.

Information about the Differential thermostat function is shown in chapter "Operation info".

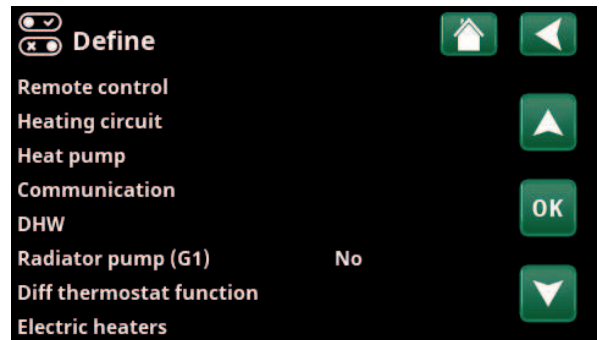

Menu: "Installer/Define".

14.11.7 Def. Immersion heater

Tariff EL ext. config. **None (NO/NC/None)**

The function can block the immersion heater at times of high electricity tariffs by means of an external signal.

This menu defines the Normally Open (NO) or Normally Closed (NC) mode for the external control signal when remotely controlling the function.

For examples of normal mode settings, refer to the "Def. Remote Control" section of the "Installer/Define" chapter.



Menu: "Installer/Define/Immersion heater".

14.11.8 Def. External heat source (EHS)

External heat source/Diff. thermostat can be defined together with either "Active cooling" or "External boiler" because the functions share the same inputs and outputs on the relay card.

External heat source **No (No/Yes)**

Specify here whether an "External heat source" should be connected ("Yes").

14.11.9 Def. External boiler

External boiler can be defined together with either "External heat source/Diff. thermostat" or "Active cooling" because the functions share the same inputs and outputs on the relay card.

External boiler **Yes (No/Yes)**

Specify here whether "External boiler" should be used.

Map to relay **A2 (A2/A3)**

Specify whether the external boiler is connected to relay card A2 or expansion card A3.

The menu bar is only displayed if passive cooling is defined in the "Installer/Define/Cooling" menu.

External control **NC (NO/NC/None)**

Determine the normal mode (Normally Open (NO) or Normally Closed (NC)) for the external control signal when controlling the function with a remote control.

This menu bar is only displayed if the input "Tariff ext. boiler" is defined in the "Installer/Define/Remote control" menu.



Menu: "Installer/Define/External heat source".

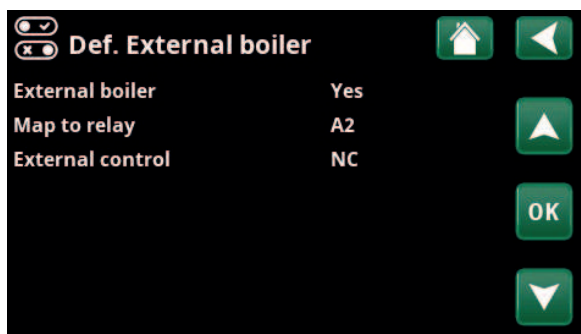

Menu: "Installer/Define/External boiler".

14.11.10 Def. Cooling

Active cooling is regulated with primary flow sensor 2 (B2), which means that active cooling and heating circuit 2 cannot be used at the same time.

Active cooling can be defined together with either "External heat source/Diff. thermostat" or "External boiler" because the functions share the same inputs and outputs on the relay card.

Cooling **Active (Passive/No/Active)**

Selection "Passive" means that passive cooling is used. Selection "Active" means that the compressor produces cooling.

Common Heating/Cooling **No (Yes/Yes with G11/No)**

Selection "Yes" means that cooling and heating are distributed in the same heating circuit.

Selection "Yes with G11" means that the heat pump's charge pump also runs when cooling is required.

Condense secured? **No (No/Yes)**

The menu bar is displayed when passive cooling has been selected (option "Passive").

If the system is condensation-proofed, significantly lower temperatures are permitted at various points in the system. **WARNING!** Build-up of condensation in the house structure can lead to damp and damage from mildew.

"No" means a setting range for room temperature of 18-30 °C and "Yes" means a setting range of 10-30 °C

In the event of doubt, contact a professional for an assessment.

Cooling tank **No (No/Yes)**

Select "Yes" if the cooling tank is connected to the system.

Radiator pump (G2) **No (No/Yes)**

Select "Yes" if radiator pump G2 is connected to the system.

The menu bar is displayed for the following menu selection:

- Common Heating/Cooling: No
- Cooling tank: No

Room sensor **No (Yes/No)**

Specify whether room sensors are to be connected to the heating circuit.

Type **Cable/SmartControl**

Select whether the heating circuit room sensor is:

- **Cable**
Wired room sensor.
- **SmartControl**
SmartControl is a separate series of wireless accessories. If "SmartControl" is selected, the connection channel must be selected in the row below. These accessories must be connected to the heating circuit via the "Installer/Define/SmartControl" menu. Refer to the separate "Installation and Maintenance Manual" for the SmartControl accessory.

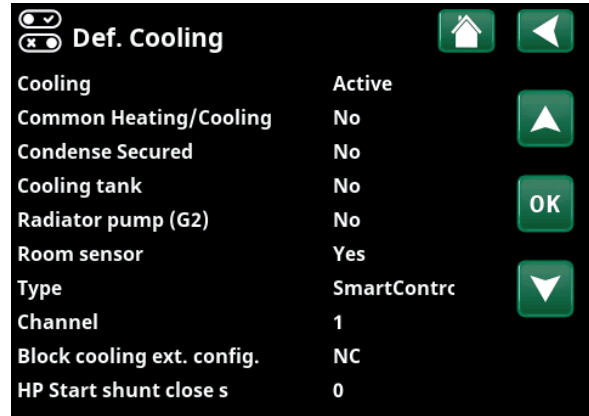

Menu: "Installer/Define/Cooling".

! A room sensor must always be used in that part of the property which is to be cooled, as it is the room sensor which determines/controls cooling capacity.

Block Cooling, ext. config. **None (None/NC/NO)**

This menu bar is displayed if an "Input" for remote control is defined for the "Block Cooling" function in the "Installer/Define/Remote Control" menu.

The function can be used to turn off cooling with the help of a humidity sensor when there is a risk of condensation. This menu defines the Normally Open (NO) or Normally Closed (NC) mode for the external control signal when remotely controlling the function.

For examples of normal mode settings, refer to the "Def. Remote Control" section of the "Installer/Define" chapter.

HP Start, Shunt close (s) **180 (0...240)**

Displayed when the cooling tank is defined in the system. When the heat pump starts, the shunt Y2 closes this time (seconds).

14.11.11 Def. SMS

Activate **No (Yes/No)**

If "Yes" is selected, the menus below are displayed:

Level of signal

The signal strength of the reception is shown here.

Phone Number 1

The first activated phone number is shown here.

Phone Number 2

The second activated phone number is shown here.

Hardware Version

The hardware version of the SMS accessory is shown here.

Software Version

The software version of the SMS accessory is shown here.

NB: For more information about the SMS function, refer to the "Installation and Maintenance Manual" for CTC SMS.

14.11.12 Def. SmartControl

SmartControl is a separate series of wireless accessories.

SmartControl **No (Yes/No)**

If "Yes" is selected, SmartControl accessories can be connected to the heating circuit. Refer to the connection procedure in the separate SmartControl Accessories manual.

14.11.13 Def. Current sensor

Current sensor **Yes (Yes/No)**

Select "Yes" if current sensors are to be connected to the system.

For more information, refer to the "Current Sensors" section in the "Installer/Settings" chapter.

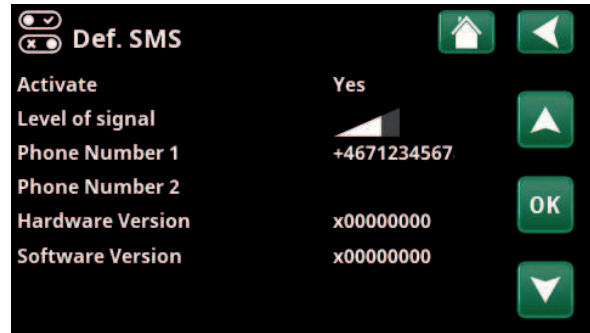

Menu: "Installer/Define/ SMS".

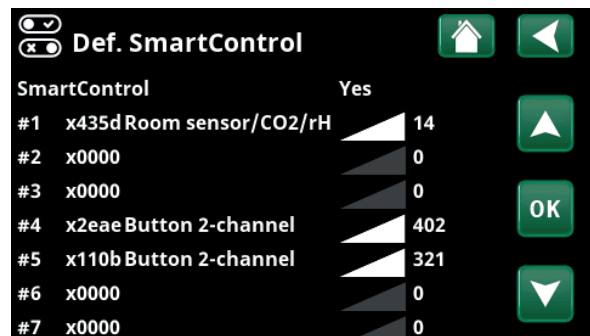

Menu: "Installer/Define/SmartControl".



14.12 Service



NB: This menu is intended for the installer only.

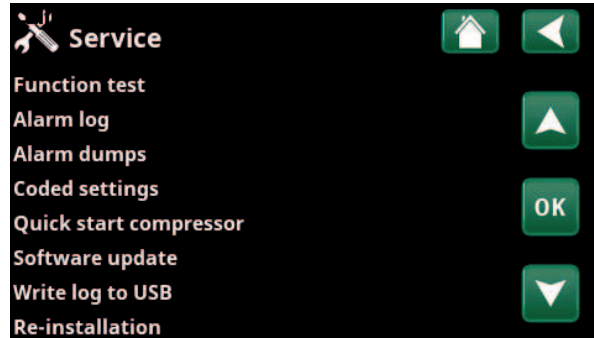

Menu: "Installer/Service".

14.12.1 Function test

From this menu, the installer can test the connection and function of separate components of the heating circuit. When this menu is activated, all control functions are stopped. The only protection against incorrect operation are the pressure sensors and the immersion heater's overheating protection device. The heat pump returns to normal operation after 10 minutes of inactivity or when exiting the "Function Test" menu. When the menu is opened, all automatic functions are stopped and testing can be performed.



When you exit the menu, the heat pump returns to normal operation.

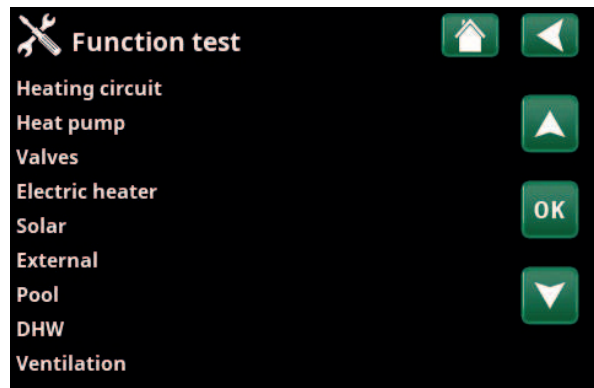

Menu: "Installer/Service/ Function Test".

14.12.1.1 Test Heating Circuit

If several heating circuits have been installed, they will all be displayed here.

Heating circ pump (1-) Off (On/Off)

Starts and stops the respective radiator pump.

Mixing valve (1-)

Opens and closes the respective mixing valve.

LED room sensor Off (On/Off)

The room sensor alarm functions can be controlled from here. When activated, the respective room sensor's red LED comes on steady.

Cooling valve Off (On/Off)

Switches the cooling valve Y61 on or off if "Active cooling" is defined in the "Installer/Define/Cooling" menu.

Cooling demand relay Off (On/Off)

Switches the cooling valve Y62 on or off if "Active cooling" is defined in the "Installer/Define/Cooling" menu.

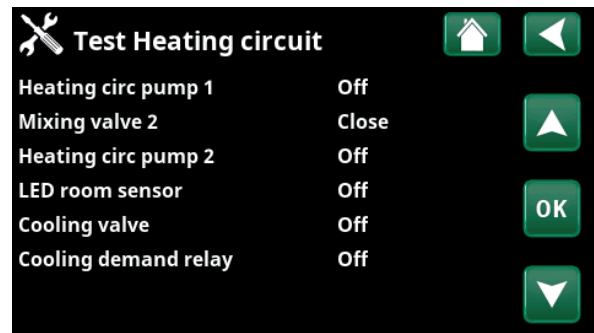

Menu: "Installer/Service/ Function Test/Heating Circuit".

14.12.1.2 Test Heat Pump

HP Compressor Off (On/Off)

When the compressor is being function tested, the brine and charge pump are also operating so that the compressor does not trigger its pressure switches.

HP Brine pump/Fan Off (Off/On)

Function test brine pump or fan (air-to-water HP).

HP Charge pump 0 (0...100%)

Function test charge pump 0–100%.

Defrost Manually Off (Off/On)

When the "Manual defrosting" function is tested, a defrosting cycle will be performed in the air-to-water heat pump. Defrosting cannot be stopped once it has been started and the defrosting programme will be completed.

Compressor heater Off (Off/On)

Function test compressor heater.

Drip tray heater Off (Off/On)

Function test of the condenser tray heater.

Heating cable Off (Off/On)

Function test heating cable.

4-way valve (Y11) Off (Off/On)

Function test 4-way valve (Y11). Fitted to air-to-water HP.

Exp. valve /2 % 0 (0...100)

Function test expansion valve. This menu bar is displayed depending on heat pump model.

14.12.1.3 Test Valves

The following valves are function tested from this menu:

3-way valve HS/DHW

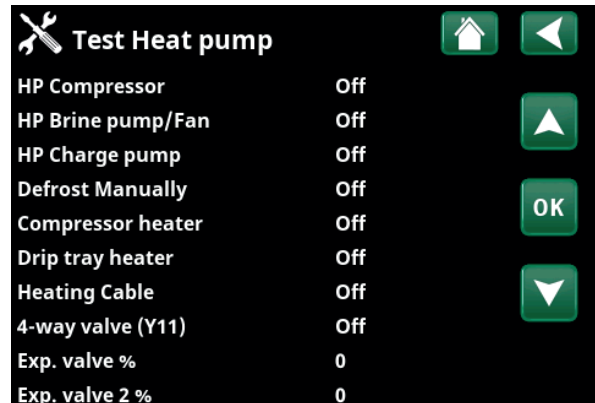

Menu: "Installer/Service/Function Test/Heat Pump".



Menu: "Installer/Service/Function Test/Valves".

14.12.1.4 Test Immersion heaters

Tests the immersion heaters per phase and step (On/Off).

Immersion heater L1A Off (Off/On)

Immersion heater L1B Off (Off/On)

Immersion heater L2A Off (Off/On)

Immersion heater L2B Off (Off/On)

Immersion heater L3A Off (Off/On)

Immersion heater L3B Off (Off/On)

Immersion heater A13 Off (Off/On)

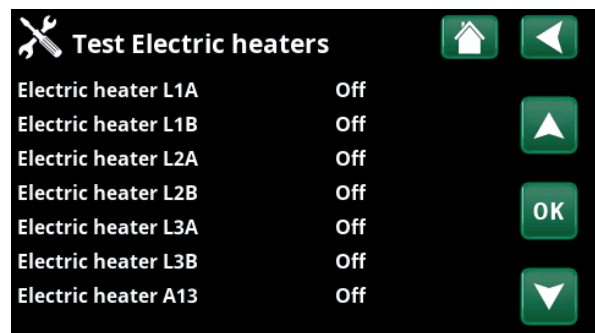

Menu: "Installer/Service/ Function Test/Immersion heaters".

14.12.1.5 External test (Diff Thermostat/EHS/External boiler)

Pump (G46) Off (On/Off)

Function test of charge pump for EHS.

Mixing valve (Y41) Close (- /Close/Open)

Function test of mixing valve for EHS.

Mixing valve (Y42) Close (- /Close/Open)

Function test of mixing valve for External Boiler.

Ext. Boiler Off (On/Off)

Function test of external boiler.

Temperatures

EHS-tank °C (B47) 0 °C

Shows temperature value on sensor in EHS-tank.

Diff thermostat °C (B46) 0 °C

Shows temperature value on sensor for diff thermostat tank.

Ext. Boiler °C (B9) 0 °C

Shows temperature value on sensor in external boiler.

14.12.1.6 Test DHW

Tap water pump (G5) 0% (0...100)

Function test of the tap water pump for hot water.

DHW circulation pump (G40) Off (On/Off)

Test of hot water circulation pump.

Sensor

DHW °C (B25) 0 °C

Displays current hot tap water temperature.

Flow sensor (B102) Off (On/Off)

Shows whether there is a flow in the DHW pipe.

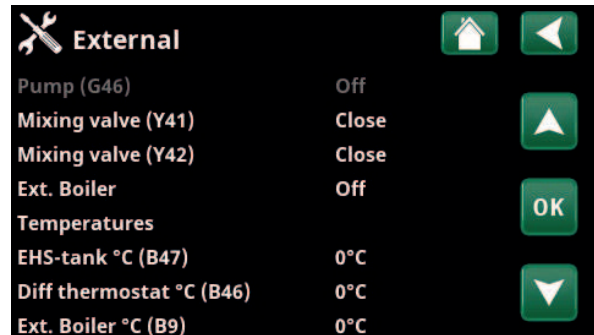

Menu "Installer/Service/External test".

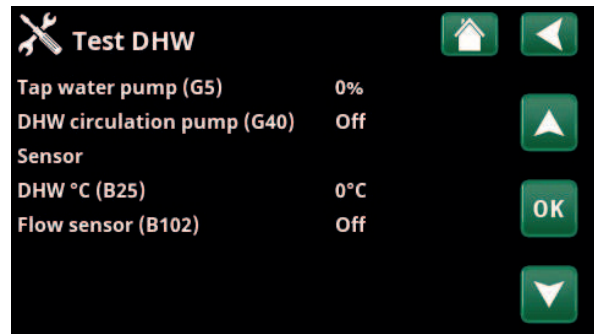

Menu "Installer/Service/Test DHW".

14.12.2 Alarm log

In the alarm log, up to 500 alarms can be displayed at the same time.

An alarm which reoccurs within an hour is ignored so as not to fill up the log.

Click an alarm row to see more information about an alarm.

If it is a "sensor alarm", a sensor value will be displayed at the bottom of the page from when the alarm was triggered for further troubleshooting.

For alarms related to the heat pump, values can be displayed from sensors for pressure (HP, LP), temperature (SH=Superheating) and current (I).

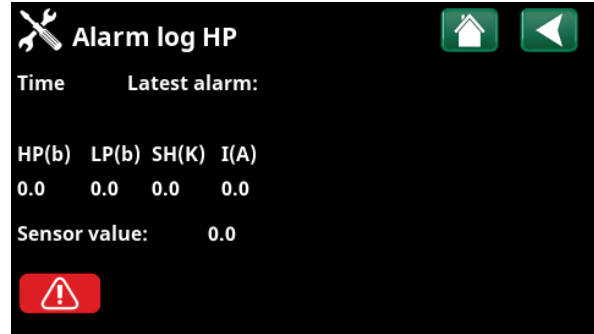

Menu: "Installer/Service/ Alarm log".

! NB: Only an authorised service engineer is allowed to log in to the Factory settings coded option. Severe operational problems and faults may occur affecting the product if values are amended without authorisation. Note that in such cases the warranty terms do not apply.

14.12.3 Alarm dumps

Export the alarms displayed in the alarm log to a USB drive. A dump can consist of one or more alarms as well as specific values before and after the alarm was triggered.

14.12.4 Coded settings

This menu is intended to set the manufacturer's operational and alarm limits. A 4-digit code must be specified to be able to amend these limits. However, you can also look without any code to see what options feature in the menu.

14.12.5 Quick start compressor

The delay normally prevents compressor start earlier than 10 mins after compressor stop. The delay is also activated in the event of a power failure, or the first time after production is started. This function speeds up this process.

For "System Types" 1 to 3, the degree minute loss is set to the value that starts all heat pumps.

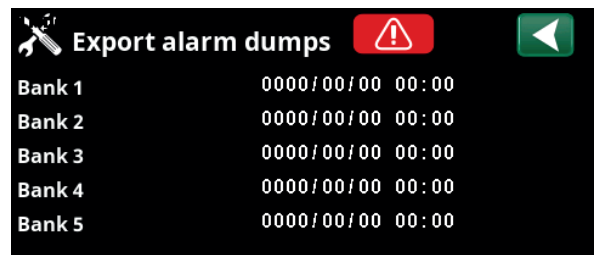

Menu: "Installer/Service/Alarm Dumps".

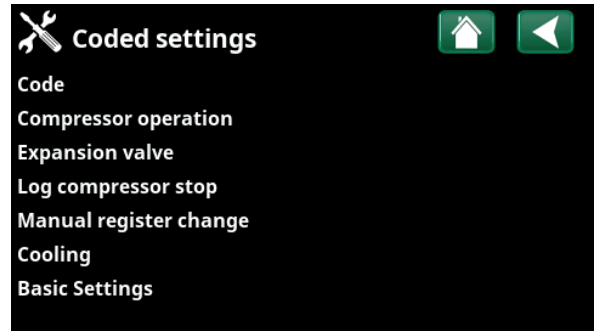

Menu: "Installer/Service/Coded settings".

14.12.6 Software update

The display software can be updated either via USB drive or online. The rows are greyed out until the USB drive is installed or the display is connected to the internet.

Click OK to confirm the upload.

The settings are retained during updating, but the old values are overwritten by any new factory values.

14.12.7 Write log to USB

Intended for service engineers. This function can be used to save logged values to a USB memory stick.

14.12.8 Re-installation

This command relaunches the installation sequence. First, confirm that you want to reinstall to access the installation wizard, refer to the "Installation Guide" and "First Start" chapters.

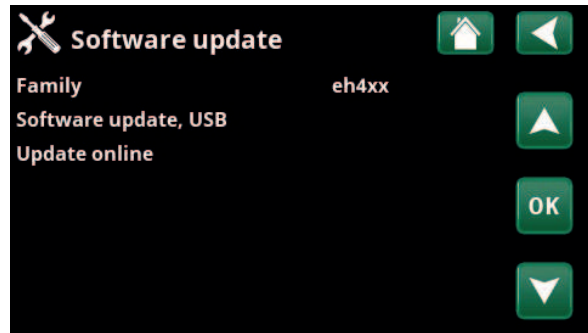

Menu: "Installer/Service/ Software Update".

! NB: The power to the product must not be interrupted, under any circumstances, during the update process.

! NB: Turn off the power and always restart the product after software update. Several minutes may pass before the display communicates clearly after restart.

15. Factory settings EcoZenith i360

Designation	Factory setting	Min value	Max value	Alternative		Set during Installation
Heating circuit						
Program Economy	-					
Room temp change °C	-2.0	-5.0	-0.1			
Off delay, min	30	10	600			
Program Comfort	-					
Room temp change °C	2.0	0.1	5.0			
Off delay, min	30	10	600			
Max primary flow °C	55	30	70			
Min primary flow °C	Off	15	65			
Heating, mode	Auto			Auto On	Off	
Heating mode, ext	-			Auto On	Off	
Heat off, out °C	18	2	30			
Heating off, time (min)	120	30	1440			
Heating on, time (min)	120	30	1440			
Night reduction down to °C	5	-40	40			
Room temp reduced, night red. °C	-2	-40	0			
Room temp. reduced, holiday °C	-2	-40	0			
Prim. flow reduced, night red. °C	-3	-40	0			
Prim. flow reduced, holiday °C	-3	-40	0			
Alarm room temp °C	5	-40	40			
SmartGrid Low price °C	Off	1	5			
SmartGrid Overcapacity °C	Off	1	5			
SmartGrid Blocking	Off			On		
Max time heating (min)	20	10	120			
Charge pump %	60	25	100			
Drying period mode	Off	1	3			
Drying period temp °C	25	25	55			
Heat pump						
Compressor	Blocked			Permitted		
Brine pump (CTC EcoPart)	Auto			10d	On	
Stop at outdoor °C (EcoAir)	-22	-22	10			
Compressor stop at brine °C	-5	-15	10			
Tariff HP	No			Yes		
SmartGrid Block. HP	No			Yes		
Start at degree minute	-60	-900	-30			
Start at degree minute cooling	60	30	900			
HS<->DHW time (sec)	120	30	240			
Max RPS	100	50	120 (80)			
Max RPS warm temp	50	50	100			
Ext. noise reduction RPS	50	20	100			
Cold temp limit	0	-15	0			
Warm temp limit	20	0	20			
Passive cooling brine pump on	On			On	Off	

Designation	Factory setting	Min value	Max value	Alternative		Set during Installation
Defrost heating Temp Min m	10	0	360			
Defrost heating Temp Max m	10	0	360			
Defrost heating Temp Min °C	10	-40	40			
Defrost heating Temp Max °C	-10	-40	40			
Immersion heater						
Max immersion heater kW	9.1*	0	11.9/9/10*			
Max immersion heater DHW kW	9.1*	0	11.9/9/10*			
Start at degree minute	-500	-900	-30			
Diff step, degree minute	-50	-300	-20			
Main fuse A	20	10	90			
Conv. factor curr. sensors	1	1	10			
Tariff EL	No			Yes		
SmartGrid Block. immersion	No			Yes		
Hot water (DHW tank)						
Program DHW	Normal/ Economy/ Comfort					
Charge start %	No/No/No					
Charge stop upper/lower °C	55/50/58					
Charge start lower °C	40/40/53					
DHW °C	50/45/45					
Permitted Add.heat, outdoor °C	No/No/No					
Start/stop diff upper °C	5	3	7			
Max time DHW (min)	30	10	150			
Charge pump %	50	20	100			
SmartGrid Blocking °C	Off	-50	-1			
SmartGrid Low price °C	Off	1	30			
SmartGrid Overcapacity °C	Off	1	30			
SmartGrid Overcapacity block HP	No			Yes		
Min RPS DHW charging	50	50	100			
Run time DHW circ. (min)	4	1	90			
Time DHW circ. (min)	15	5	90			
Add. heat DHW	No			Yes	Auto	
Time ExtraDHW Remote control	0.0	0.0	10.0			
HC2 Mixing valve close	120	1	300	Off		
External heat source (EHS)						
Charge start °C	70	20	90			
Stop diff. °C	5	1	15			
SmartGrid Blocking cap.	No			Yes		
Diff thermostat function						
Charge start diff temp °C	7	3	30			
Charge stop diff temp °C	3	2	20			
Charge temperature °C	60	10	80			

*Applies to 3x400V, for other variants see Electrical data - Technical data.

For language choices "German" and "French" the max electric power is factory set at 0.0 kW.

Designation	Factory setting	Min value	Max value	Alternative		Set during Installation
External Boiler						
Ext. Boiler mode	Auto			On	Off	
Boiler start out temp.	0	-30	30			
Delay stop ext boiler	0	0	1440			
Boiler, open mix.valve °C	70	20	90			
Stop diff. °C	5	1	15			
Start boiler, degree minute	-300	-900	-30			
Priority DHW tank	Low			High		
SmartGrid Block. boiler	No			Yes		
Tariff ext boiler	No			Yes		
Ext boiler diff °C	3	Off/1	15			
Cooling						
Room temp. cooling °C	25.0	18.0	30.0			
Cooling permit. from outdoor T °C**	Off	0	39			
Active delay**	10	1	600	Off		
Heating off, delay**	10	0	600			
Start delay**	180	1	240	Off		
Diff. delay calc.**	10	1	600	Off		
Primary flow diff at outdoor T +20 °C**	2	1	10			
Primary flow diff at outdoor T +40 °C**	2	1	10			
Tank max °C	30	10	50			
Tank min °C	5	5	50			
Max time, Cooling (min)	20	1	150			
SmartGrid Low price. °C	Off	1	5			
SmartGrid Overcapacity °C	Off	1	5			
Ext. block cooling	No			Yes		

***Displayed if "Active cooling" has been defined.*

16. Troubleshooting

16.1 Troubleshooting, heat

Problem	Cause	Action
Temperature too cold	The current monitor limits the heat pump power	The information message "High curr., reduced elec. (X A)" is shown. An electrician can adjust the load of the three phases or change the fuse size.
	Insufficient power permitted	Check that the power is not limited by the current monitor/excessively high current in the house.
		Identify current sensor, otherwise limits the phase with the highest load. Touchscreen: "Installer/Service/Control current sensors".
	Permitted immersion heater power is too low	Increase the permitted power, touchscreen: "Installer/Settings/Immersion heater/Max immersion heater kW".
Max permitted primary flow temperature set too low	"Installer/Settings/Heating Circuit", increase "Max primary flow °C".	
Incorrect temperature	Heating curve set incorrectly	Change inclination (when outdoor temperature < 0°C) "Installer/Settings/Heating circuit". Change inclination °C.
		Change adjustment (when outdoor temperature > 0°C) "Installer/Settings/Heating circuit". Change adjustment °C.
	Temperature reduction activated in error	Install room sensor.
Heat source out of order	Change on touchscreen: "Installer/Settings/Heating circuit" or "Room temp", "Night reduction" or "Holiday".	
Uneven indoor temperature	Air in radiator system	Make sure the heat pump or other heat source is operational and that no error messages are shown. Contact the installation engineer in the first instance.
	Radiator system set up incorrectly	Bleed the radiator system.
		Open the radiator thermostats completely. Evaluate after a few days, if too warm in any room, the thermostat can be turned down.
Room sensor incorrectly situated	Fault in radiator, should be evenly hot, replace.	
	Change the placement so that the room sensor reflects the indoor temperature of the house.	
	Make sure the room sensor is not in direct sunlight or by a door or staircase with uneven air circulation.	
		The room sensor functions best in an open-plan layout.

16.2 Troubleshooting, hot water

Cause	Action
Incorrect pressure in system	Check pre-pressure in the expansion tank with a pressure gauge. 0.5–0.6 bar. Fill the heating circuit; pressure should increase to approx. 1–1.5 bar.
Air pockets in various parts of the system	Bleed the tank, turn the safety valve.
	Bleed the tank, check that the automatic bleeder on the tank works.
	Carry out a function test on the diverting valve, touchscreen: “Installer/Service/Function test”. Valves – 3-valve change between DHW and HS.
	Carry out a function test on the hot tap water pump, touchscreen: “Installer/Service/Function test”. Hot water – tap hot water pump. Increase and decrease speed.
	Increase the system pressure to 2.5 bar by filling the radiator system; then test the safety valve; water and air pockets are released.
Cold water from the building mixer is leaking back. Causes dilution of hot water	Test the kitchen mixer on full heat, switch off, and then open the tap in the shower/bathroom straight away. If the hot water pipe under the kitchen mixer cools down quickly, it is leaking cold water backwards. Replace the mixer.
Hot water is collecting up too quickly. The DHW heat exchanger is not managing to transfer heat.	Let the water into the bathtub a little more slowly and use a low-flow shower head.
Hot water requirements set incorrectly	Increase level, touchscreen: “DHW/Economy”, “Normal” or “Comfort”.
Heat source out of order	Make sure the heat pump or other heat source is operational and that no error messages are shown. Contact the installation engineer in the first instance.

16.3 Information messages

Information messages are displayed when appropriate and are intended to inform users about various operational situations.



[I002] HC1 Heating off

[I005] HC2 Heating off

Shows for each heating circuit that the product is operating in summer mode when only DHW is required, not heating.

[I008] Tariff HP off

Indicates that Tariff has switched off the heat pump.

[I009] Compressor blocked

The compressor is set to be shut down, e.g. before drilling or digging has been carried out for the collector coils. The product comes with the compressor switched off. This option is selected in the "Installer/Settings/Heat Pump" menu.

[I010] Tariff EL Off

Shows that tariff has switched off the immersion heater elements.

[I011] Round circulation

Indicates that round circulation is active. Round circulation is a device which an electricity supplier can fit with the aim of disconnecting high current draw equipment for a short period of time. The compressor and electrical output are blocked when round circulation is active.

[I012] High curr., reduced elec.

- The property's main fuses risk being overloaded due to, for example, the simultaneous use of several power-hungry appliances. The product reduces the electrical heaters' electrical output during this period.
- 2h max. 6 kW. Electric heating elements are limited to 6 kW for 2 hours after being switched on. This message appears if more than 6 kW are required during the product's first 2 hours of operation. This is applicable after a power outage or a new installation.

[I013] Start delay

The compressor is not allowed to start too quickly when it has stopped. The delay is usually at least 10 minutes.

[I014] Drying period active, d

Indicates that the floor function is active and displays the time (days) remaining that the function will be active.

[I017] SmartGrid: Blocking

[I019] SmartGrid: Low price

[I018] SmartGrid: Overcapacity

The product is externally affected by "SmartGrid". See also "Define/Remote control/SmartGrid".

[I021] Ext. Ctrl Heating 1

[I022] Ext. Ctrl Heating 2

The remote control affects whether the heating is to be on or off. If the heating is switched off, "Heating off, heating circuit 1/2" is also displayed.

[I028] Holiday period

Displayed when setting the holiday schedule, which entails lowering the room temperature and that no hot water is produced.

[I029] Bleeding DHW in progress

During the bleeding process, hot water will not be supplied at a continuous temperature. Hot water production can start when the bleeding process is complete and the message is no longer displayed.

[I030] Driver block under voltage

The heat pump has stopped due to insufficient mains voltage. The product will attempt to restart.

[I031] Driver block alarm

The heat pump has stopped due to driver failure; for example, voltage or excessive temperature. The product will attempt to restart.

16.4 Alarm messages

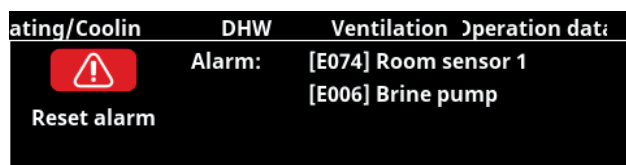

If a fault occurs with e.g. a sensor, an alarm is triggered. A message appears on the display with information about the fault.

You reset the alarm by pressing the Reset Alarm button on the display. If several alarms are triggered, they are displayed one after the other. A persisting fault must first be rectified before it can be reset. Some alarms are reset automatically if the fault ceases.

Alarm messages	Description
[E010] Compressor type?	This message appears if no information about the compressor type is available.
[E013] EVO off	This message appears when there is a fault with the expansion valve control.
[E024] Fuse blown	This message appears when the fuse (F1, F2) has been triggered.
[E026] Heat pump	This message appears if the heat pump is in alarm mode.
[E027] Comm. error HP	This message is displayed when the display card (A1) cannot communicate with the HP control card (A5).
[E063] Comm. err. relay board	This message is displayed when the display card (A1) cannot communicate with the relay card (A2).
[E056] Comm. err. motor protection	This message is displayed when the HP control card (A5) cannot communicate with the motor protection (A4).
[E086] Comm. err. expansion card	This message is displayed when the display card (A1) cannot communicate with CTC Solar control/Expansion card (A3).
[E035] High pressure switch	The refrigerant's high pressure switch has been triggered. Press reset and check whether the alarm recurs. If the fault recurs, contact your installer.
[E040] Low brine flow	Low brine flow is often caused by air in the collector system, especially immediately following installation. Collectors which are too long can also be a cause. Press reset and check whether the alarm recurs. Also check the brine filter that has been installed. If the fault recurs, contact your installer.
[E041] Low brine temp.	Incoming brine temperatures from bore hole/ground loop are too low. Press reset and check whether the alarm recurs. If the fault recurs, contact your installer to check the dimensions of the cold side.
[E044] Stop, high compr temp	This message appears when the compressor temperature is high. Press reset and check whether the alarm recurs. If the fault recurs, contact your installer.
[E045] Stop, low evaporation	This message appears when the evaporation temperature is low. Press reset and check whether the alarm recurs. If the fault recurs, contact your installer.
[E046] Stop, high evaporation	This message appears when the evaporation temperature is high. Press reset and check whether the alarm recurs. If the fault recurs, contact your installer.
[E047] Stop, low suct. gas exp. valve	This message appears when the suction gas temperature is low. Press reset and check whether the alarm recurs. If the fault recurs, contact your installer.
[E048] Stop, low evap. exp. valve	This message appears when the expansion valve's evaporation temperature is low. Press reset and check whether the alarm recurs. If the fault recurs, contact your installer.
[E049] Stop, high evap. exp. valve	This message appears when the expansion valve's evaporation temperature is high. Press reset and check whether the alarm recurs. If the fault recurs, contact your installer.

Alarm messages	Description
[E050] Stop, low overheat. exp. valve	This message appears when the expansion valve's overheat temperature is low. Press reset and check whether the alarm recurs. If the fault recurs, contact your installer.
[E052] Phase 1 missing [E053] Phase 2 missing [E054] Phase 3 missing	This message appears in the event of a phase failure.
[E055] Wrong phase order	The product's compressor motor must rotate in the right direction. The product checks that the phases are connected correctly; otherwise, an alarm is triggered. This will require changing two of the phases into the product. The power supply to the system must be shut off when rectifying this fault. This fault generally only occurs during installation.
[Exxx] Alarm 'sensor'	<p>An alarm message is displayed if an error occurs with a sensor that is not connected or has short-circuited and if the value is outside the sensor's range. If this sensor is important to the system's operation, the compressor stops. This requires the alarm to be reset manually after the fault has been rectified. The alarm is reset automatically after correction for the following sensors:</p> <p>[E140] Sensor EHS-tank (B47), [E031] Sensor prim flow 1 (B18), [E032] Sensor prim flow 2 (B2), [E074] Outdoor sensor (B15), [E074] Room sensor 1 (B11), [E075] Room sensor 2 (B12), [E005] Brine out sensor, [E003] Brine in sensor, [E028] HP in sensor, [E029] HP out sensor, [E037] Hot gas sensor, [E080] Suction gas sensor, [E036] High pressure sensor, [E043] Low pressure sensor.</p>
[E057] Motor protect high curr.	High current into the compressor has been detected. Press reset and check whether the alarm recurs. If the fault recurs, contact your installer.
[E058] Motor protect low curr.	Low current into the compressor has been detected. Press reset and check whether the alarm recurs. If the fault recurs, contact your installer.
[E061] Max thermostat	<p>This alarm message appears if the product becomes too hot.</p> <p>During installation, make sure the max. thermostat (F10) has not been triggered as there is a chance of this occurring if the boiler has been stored in extremely cold temperatures, Reset it by pressing in the button on the electrical switchboard behind the front panel.</p>
[E135] Risk of freezing	Alarm indicating that the temperature of the outgoing water from the heat pump (HP out) is too low for defrosting. The water volume in the system may be too low. The flow may be too low. (Applies to EcoAir)
[E152] 4-way valve	This alarm message is displayed if a fault occurs with EcoAir's 4-way valve or if the connection pipes to the EcoAir are incorrectly connected. Press reset and check whether the alarm recurs. If the alarm recurs, check that the charge pump is pumping water to the heat pump's lower connection. If the fault recurs, contact your installer.
[E087] Driver	Press reset and check whether the alarm recurs.
[E088] Driver: 1 - [E109] Driver: 29 Driver fault.	If the fault recurs, contact your installer and tell them the error code number where applicable.
[E117] Driver: Offline	Communication error. The electrical connection box and driver of the heat pump are not communicating.
[E163] Defrost max time duration	The heat pump has not had time to complete defrosting within the maximum time. Make sure that any ice on the evaporator has disappeared.

16.5 Critical alarms - Risk of freezing



- [E135] Risk of freezing (after four alarms, a new alarm is displayed [E218])
- [E211] Risk of freezing low flow (after four alarms, a new alarm is displayed [E219])
- [E216] HP flow temp diff (after four alarms, a new alarm is displayed [E220])
- [E217] HP Charge pump flow (after four alarms, a new alarm is displayed [E221])

If a critical alarm is shown on the display, take the action described below. Confirm the alarm by entering code 4005 in the display menu "Installer/Service/Coded settings/Code".

Please note: The critical alarms can be acknowledged three times by entering code 4005. **After four alarms, the heat pump is blocked;** in this case, contact the installer. After one year of operation without any alarms, the critical alarms are reset.

! The critical alarms [E135], [E211], [E216] and [E217] can be acknowledged three times by entering code 4005. After four alarms, the heat pump is blocked.

[E135] Risk of freezing

Applies to all air/water heat pumps controlled by CTC EcoLogic L/M/S, CTC EcoZenith i255/i360/i555 and CTC EcoVent i360F.

Alarm conditions

If the temperature of the water exiting the heat pump (HP out) is lower than 15 °C during a defrost period or if there is more than 15 °C difference between HP in and HP out for more than 20 seconds.

Possible cause

- The circuit temperature and/or flow rate is too low.
- If the sensors (HP in and HP out) do not display the correct value, alarm [E135] can be generated. Check the temperatures using an external thermometer.

Action

- Ensure that the return flow of the heating circuit is at a minimum of 25°C during a defrost period. In the event of low temperature, contact the installer.
- Supplement with a volume tank.
- Check the circulation pump, dirt filter, pipe system and pipe size to ensure flow requirements are met.
- Check the sensors (HP in and HP out) and replace as required.

[E211] Risk of freezing low flow

Applies to CTC EcoAir 600M with the "Flow Sensor" accessory installed, and EcoAir 700M.

Alarm conditions

The flow is less than 10 l/min (EcoAir 610M/614M/708M/712M) or 15 l/min (EcoAir 622) for more than 30 seconds during a defrost period.

Possible cause

- The circuit temperature and/or flow rate is too low.

Action

- Check the circulation pump, dirt filter, pipe system, pipe size and flow sensor to ensure flow requirements are met.

[E216] HP flow temp diff

Applies to CTC EcoAir 500/600M/700M.

Alarm conditions

The difference between HP in and HP out exceeds 12 °C in heat operation for more than 15 minutes.

Possible cause

- The circuit temperature and/or flow rate is too low.

Action

- Check the dirt filter, pipe system and speed settings of the circulation pump to ensure flow requirements are met.
- Check the sensors (HP in and HP out) and replace as required.

[E217] HP Charge pump flow

Applies to CTC EcoAir 400.

Alarm conditions

The charge pump speed exceeds 70% during heat operation for more than 15 minutes.

Possible cause

- The circuit temperature and/or flow rate is too low.

Action

- Check the dirt filter, pipe system and speed settings of the circulation pump to ensure flow requirements are met.

www.ctc.se, www.ctc-heating.com
+46 372 88 000
Fax: +46 372 86 155
P.O Box 309 SE-341 26 Ljungby Sweden



MADE IN SWEDEN